

A
DISSERTATION
ON

**“HOME AUTOMATION USING
ARDUINO”**

SUBMITTED IN PARTIAL FULFILMENT OF THE REQUIREMENTS FOR THE
AWARD OF DEGREE OF

**BACHELOR OF VOCATION
IN
HARDWARE TECHNOLOGY AND NETWORKING**



SUBMITTED BY
**KU. SUPRIYA PRADIP NAGDEOTE
KU. PRIYA BHOLARAM REHPADE**

UNDER THE GUIDANCE OF
ASST. LEC.A.P. RAMTEKE

**DEPARTMENT OF BACHELOR OF VOCATION
BHIWAPUR MAHAVIDYALAYA
BHIWAPUR
2022-2023**

A
DISSERTATION
ON

**“HOME AUTOMATION USING
ARDUINO”**

SUBMITTED IN PARTIAL FULFILMENT OF THE REQUIREMENTS FOR THE
AWARD OF DEGREE OF

**BACHELOR OF VOCATION
IN
HARDWARE TECHNOLOGY AND NETWORKING**



SUBMITTED BY
**KU. SUPRIYA PRADIP NAGDEOTE
KU. PRIYA BHOLARAM REHPADE**

UNDER THE GUIDANCE OF
ASST. LEC.A.P. RAMTEKE

**DEPARTMENT OF BACHELOR OF VOCATION
BHIWAPUR MAHAVIDYALAYA
BHIWAPUR
2022-2023**

DEPARTMENT OF BACHELOR OF VOCATION
BHIWAPUR MAHAVIDYALAYA
BHIWAPUR, NAGPUR



CERTIFICATE

This is to certify that the project work entitled "Home Automation Using Arduio", is a bonafide work done by "Ku. Supriya Pradip Nagdeote & Ku. Priya Bholaram Rehpade" in the "Hardware Technology and Networking" section of the Bachelor of Vocation, Bhiwapur Mahavidyalaya, Bhiwapur, Nagpur, in partial fulfillment of the requirement for the award of Bachelor of Vocation in "Hardware Technology and Networking".



A.P. Ram
Project Guide

Principal

Bhiwapur Mahavidyalaya Bhiwapur

PRINCIPAL
Bhiwapur Mahavidyalaya
Bhiwapur, Dist. Nagpur

(Dr. S.R. Sharma)
Ext. Examiner

(Dr. R.K. Sharma)
Internal Examiner

(Int-Examiner)

ACKNOWLEDGEMENT

I wish to express my deepest sense of gratitude and obligation to my revered teacher and guide **Asst. Prof. A. P. Ramteke**, Hardware Technology & Networking, Department of Bachelor of Vocation, Bhiwapur Mahavidyalaya, Bhiwapur, Nagpur for his/her inspirational guidance, suggestions, constructive criticism throughout my graduate studies. I relied heavily on his professional judgment and encouragement, which benefited me immensely in carrying out this project.

I also express my sincere gratitude to Dr. Jobi George, Principal, Bhiwapur Mahavidyalaya, Bhiwapur, Nagpur, for his encouragement, and immense co-operation during my graduate studies at Bhiwapur Mahavidyalaya.

I wish to express my gratitude to my parents for sparing me to undertake this research project without any hindrances.

Ku. Supriya Pradip Nagdeote

Ku. Priya Bholaram Rehpade

Nagdeote
Rehpade

**BHIWAPUR MAHAVIDYALAYA
BHIWAPUR, NAGPUR**

DECLARATION

This Project work entitled "**Home Automation Using Arduino**", is my own work carried out under the guidance of "**Hardware Technology and Networking**" Assistant Professor in Bachelor of Vocation, Bhiwapur Mahavidyalaya, Bhiwapur, Nagpur. This work in the same form or in any other form is not submitted by me or by anyone else for the award of any degree.

Supriya. P. Nagdeote → Nagdeote

Pritya. B. Rehpade → Rehpade

CERTIFICATE

This is to certify that the Project work entitled "**Home Automation Using Arduino**", is the bonafide work done by "**Hardware Technology and Networking**" and is submitted to Bhiwapur Mahavidyalaya, Bhiwapur, Nagpur, for the partial fulfillment of the requirements for the degree of Bachelor of Vocation in "**Home Automation Using Arduino**",

ABSTRACT

Home automation system is becoming popular day by day all-over the world because of making life smoother and minimizing the work load. Considering the system's contribution toward making daily life easier and strengthening home safety and security, the necessity of development and modernization of the system is apparent. Home automation refers to the automatic and electronic control of household appliances, features and activities. The most important device of present age is mobile phone. At present Android mobile is very common and very important part of our life. Using this device in controlling and surveillance work makes our life easy and comfortable. So, this project is done in such a way we can have the control of our home through a single device. The system is composed of hardware, communication and electronic interfaces that work to integrate electrical devices with one another. The project will come in handy for the disabled and elderly people. This thesis is aimed to modernize and develop a voice controlled home automation system which allows to control all electronic devices in an apartment by voice command, provides safety by detecting fire, detects suspicious movement and also helps the owner with personal assistance. Moreover, it provides security by automatic door controlled by fingerprint sensor. Performing all these tasks with a single Android device makes everything faster because the Android makes SMS communication. It allows a person to control appliances from a remote location over the internet. The user can easily verify and close machines left on in one's absence which will help to save energy. In this project we have combined home assistance and security system with the help of a microcontroller. So this project serves as a basic structure of the AI (Artificial Intelligence) system. The programming is done in windows operating system. Sensors and serial communicating devices are incorporated and synchronized with the personal computer.

CONTENTS

Declaration.....	i
Acknowledgement.....	ii
Abstract.....	iii
List of Figures.....	vii
List of Tables.....	ix
Chapter 1: Introduction.....	1
1.1 Introduction to the Project.....	1
1.2 Motivation.....	2
1.3 Proposed System.....	3
1.4 Advantages.....	4
Chapter 2: Literature Review.....	6
Chapter 3: Brief Introduction of all Components.....	10
3.1 Introduction.....	10
3.2 Arduino ATmega 2560.....	11
3.3 Arduino UNO R3.....	12
3.4 Brief Introduction to the Sensors.....	13
3.4.1 Gas Sensor MQ-2.....	13
3.4.2 PIR Motion Detector (HC – SR501).....	14
3.4.3 Optical Dust Detector.....	14
3.4.4 LM35 Precision Temperature Centigrade Temperature Sensor.....	16
3.5 Introduction of Modules.....	17

3.5.1 Bluetooth Module HC-05.....	17
3.5.2 GSM SIM900A Module.....	19
3.5.3 Relay Module 5V 4-channel.....	21
3.5.4 Servo Motors.....	22
3.5.5 16x2 LCD Display.....	22
3.5.6 Fingerprint Recognition Module (FPM10A).....	23
3.5.7 DS1307 RTC Module.....	24
3.5.8 Buzzer.....	25
Chapter 4: Methodology.....	26
4.1 Introduction.....	26
4.2 Hardware Architecture and Implementation.....	26
4.2.1 Sensors.....	27
I. Gas Sensor.....	28
II. PIR Motion Detector.....	28
III. Optical Dust Detector.....	28
IV. LM35 Precision Temperature Sensor.....	28
4.2.2 Modules.....	28
A. GSM SIM900A Module.....	28
B. Bluetooth Module HC-05.....	29
C. 4-channel Relay Module.....	30
D. DS1307 RTC Module.....	30
E. 16x2 LCD Display.....	30
F. Pin configuration tables.....	30

4.3 Software Implementation.....	32
4.3.1 Sensors.....	33
I. Gas Sensor.....	34
II. PIR Motion Detector (HC-SR.....	34
III. Optical Dust Sensor.....	34
IV. LM35 Precision Temperature Sensor.....	35
4.3.2 Modules.....	35
A. GSM Shield SIM900A.....	35
B Bluetooth Module HC-05.....	36
C. 4 Channel Relay.....	36
D. Fingerprint Recognition Module (FPM10A).....	36
E. DS1307 Real Time Clock Module.....	38
4.3.3 Android Application.....	38
4.3.4 Voice Controlling Android Application.....	39
Chapter 5: Results and Analysis.....	40
5.1 Results.....	40
5.2 Analysis.....	46
Chapter 6: Conclusion.....	49
6.1 Discussion.....	49
6.2 Limitations.....	49
6.3 Future Scope.....	50
References.....	52
Appendix	

LIST OF FIGURES

Figure 1.1: An example of home automation system.....	4
Figure 1.2: Source of dust in air (2015).....	5
Figure 3.1: Arduino ATmega 2560.....	11
Figure 3.2: Arduino UNO R3 with pinouts.....	12
Figure 3.3: MQ 2 Gas Sensor.....	13
Figure 3.4: Pinout diagram of gas sensor.....	13
Figure 3.5: (a) PIR Motion Detector (Top view). (b) PIR Motion Detector (bottom view)...	14
Figure 3.6: Optical dust detector.....	15
Figure 3.7: Internal schematic of optical dust detector.....	15
Figure 3.8: (a) Output voltage vs. Dust density. (b) Pulse-driven wave.....	16
Figure 3.9: (a) Pin configuration of LM35 temperature sensor. (b) The graph shows linear relationship of applied voltage and temperature.....	17
Figure 3.10: Bluetooth Module HC-05 with pin configurations.....	18
Figure 3.10.1: Typical circuit connection of Bluetooth module.....	18
Figure 3.10.2: GSM SIM900A.....	19
Figure 3.10.3: Hardware of GSM SIM900A (top view).....	20
Figure 3.10.4: A 5V 4-Channel Relay Module.....	21
Figure 3.10.5: Schematic of 4-Channel Relay module.....	21
Figure 3.10.6: Servo Motor SG90.....	22
Figure 3.10.7: 16x2 LCD Display pin configuration.....	22
Figure 3.10.8: (a) Fingerprint recognition module. (b) Module pinouts.....	23
Figure 3.10.9: Transferring frame format.....	24
Figure 3.10.10: DS1307 RTC Module.....	24

Figure 3.10.11: Piezo Buzzer.....	25
Figure 4.1: Block diagram of the home automation system.....	27
Figure 4.2: Power supply block diagram of the home automation system.....	32
Figure 4.3: Flowchart of the home automation system.....	33
Figure 4.4: Motion detection software flowchart.....	34
Figure 4.5: Screenshot of Matlab code in computer.....	37
Figure 5.1: Top view of the home automation system showing different sensors and modules placed in the required places.....	40
Figure 5.2: (a) Fan OFF. (b) Fan ON.....	41
Figure 5.3: (a) Light (LED) OFF. (b) Light ON.....	41
Figure 5.4: (a) Dust sensor. (b) Response of high dust level in room.....	41
Figure 5.5: (a) Curtain open. (b) Curtain closed.....	42
Figure 5.6: (a) The user pressed finger on the scanner, the door is closed. (b) The door opened when the scanning matched.....	42
Figure 5.7: (a) Testing fire near the temperature sensor. (b) Notification of fire.....	43
Figure 5.8: (a) Notification in mobile. (b) Warning in the LCD display.....	43
Figure 5.9: (a) Testing the PIR sensor for detecting intruder. (b) Thief detection mobile notification. (c) LCD display showing thief detected.	44
Figure 5.10: (a) Light is off when no one is inside the room. (b) Light is on when someone enters the room.....	45
Figure 5.10.1: Sending text command to control fan.....	45
Figure 5.10.2: Initializing Voice Recognition App.....	46
Figure 5.10.3: Waiting for voice command.....	46

LIST OF TABLES

Table 4.1: Bluetooth pin interface.....	29
Table 4.2: Pin connection of LCD display with microcontroller.....	30
Table 4.3: Interfacing sensors with microcontroller.....	31
Table 4.4: Interfacing modules with microcontroller.....	31
Table 5.1: Expense of the security system.....	47

CHAPTER 1

Introduction

1.1 Introduction to the Project

The 21st century is the era of smart technology. It was said that modern life is unimaginable without electricity but this saying has changed. Now we say daily life is unimaginable without internet. Modern technology has advanced to another level of automatic and smart systems.

There is no need to introduce the advancement of technology in modern times. As we know, the advancement has gone a long way and almost has reached to its peak of modernization. Today innovation has turned into a coordinated piece of individuals' lives. It has and keeps on affecting numerous parts of day by day life and has permitted better social association, simplicity of transportation, the capacity to enjoy excitement and media and has helped in the advancement in pharmaceutical. One of the most important devices of modern times is Smartphone. Another important element of modern age is the internet. The key to step into the world of automatic control system is the combination of Smartphone and the internet. Therefore, with the help of these two and microcontrollers home automation was possible.

If we look few years back, people have been using washing machine, water heaters, hair dryer etc. for household chores. Not in every house in Bangladesh but in western countries these machines are used daily for household chores. We can consider these machines as the starting of home automation. Now we are able to control TV, light, fan refrigerator etc. with Android phones. This project is about easy and cheap home automation system and security system.

The quantity of Smartphone clients in Bangladesh has expanded by 3.1 million to 8.2 million in 2015, as indicated by a current report distributed by Counterpoint Technology Market Research (Dhaka Tribune). Study shows that seventy five percent of the market share is Android and a total of one hundred and six million android Smartphone were shipped in the second half of 2012. Android Smartphone became the top operating system in the market in the present time worldwide and it became the most popular operating system known to man. This is making android phone the most needed element of today's life. Home automation was possible with the help of this small device. The fast development of remote correspondence inspired us to utilize cell phones to remotely control a household appliance. Apart from houses, we have restaurants where food is served with the help of robot in Bangladesh.

Android controlled home system is not common in Bangladesh but is available in some offices to some extent. The fast development of remote correspondence inspired us to utilize cell phones to remotely control a household appliance. There is no actual definition of embedded system. Computer controlled devices can be termed as embedded systems.

With the presentation of better equipment and better programming, cell phones have turned out to be capable gadgets and have turned into an imperative piece of individuals' day by day lives. As per Li et al. (2016) there are three ages of home computerization

Firstly, wireless technology with proxy server. Example: Next Zigbee automation. Artificial intelligence controls electrical devices. Example: Amazon Echo. The latest technology is robot interacting with human. Example: Robot Rovio, Roomba.

We have good and cheap facilities to wireless networks and still developing in Bangladesh. The 2nd and 3rd generation from above, aren't available in Bangladesh. It doesn't mean that we don't want it. The government and some organizations are trying to develop our country in high technology. Now high technology is not bound within few features. The thing that takes high technology to next level is automatic system. That is why the demand of automatic electronic device is increasing. To accomplish that, home automation is necessary.

1.2 Motivation

In 2016, the CEO of Facebook, Mark Zuckerberg has built an Artificial Intelligence (AI) voice controlled assistant for his home. His inspiration came from the character "Jarvis" from the movie called Iron-Man. He has described that it is like a digital butler who can speak, play music, control lights and toasters. It can also say who is at the door. This project has made a movie character almost come to real. This excellent work of his has inspired us to do the project of home automation. There are many smart home appliances like underground refrigerator, smart closet etc. used in few luxurious houses of western countries. We believe a day will come when almost all houses will be a smart house. This project is a small step to reach this goal.

Almost every house has smart phones, smart television, smart watch, smart refrigerator, smart washing machine, smart garage which ultimately leads to a smart home. From there it is predictable that one day almost every house will be a smart house with automatic control system.

1.3 Proposed System

This wireless Arduino based system includes controlling of home appliances like light, fan, air conditioner, television, show date, time, dust sensor, room temperature, smoke and motion sensing and finger print sensor security system.

This project proposes remotely controlling of home appliances with security of home both inside and outside. The project is composed of:

1. Controlling of appliances like light, table fan, TV, air conditioner, curtains etc will be controlled with Android phone through Bluetooth communication using Bluetooth module. This is used inside the house only.
2. Density of dust level will be detected with dust sensor and purify.
3. The system will show date, day, time and temperature. For this we have chosen DS1307 RTC module. LM35 will show the temperature. All of them will be displayed in LCD 16 x 2 displays too.
4. Gas sensor MQ-2 will sense risky gas and smoke.
5. The movement of the curtains will depend on the requirement of light which is measured with Light Dependent Resistor (LDR).
6. PIR Sensor (HC – SR501) is used for motion detection.
7. Through GSM module we will control the above appliances from a distance via text messages. This will ensure safety inside the house with the help of PIR sensor.
8. The fingerprint recognition module is for automatic door locking and unlocking system.
9. Arduino Mega 2560 is the microcontroller in Windows operating system.
10. Finally all appliances are controlled by Voice Application and Android Application through Android mobile phone.

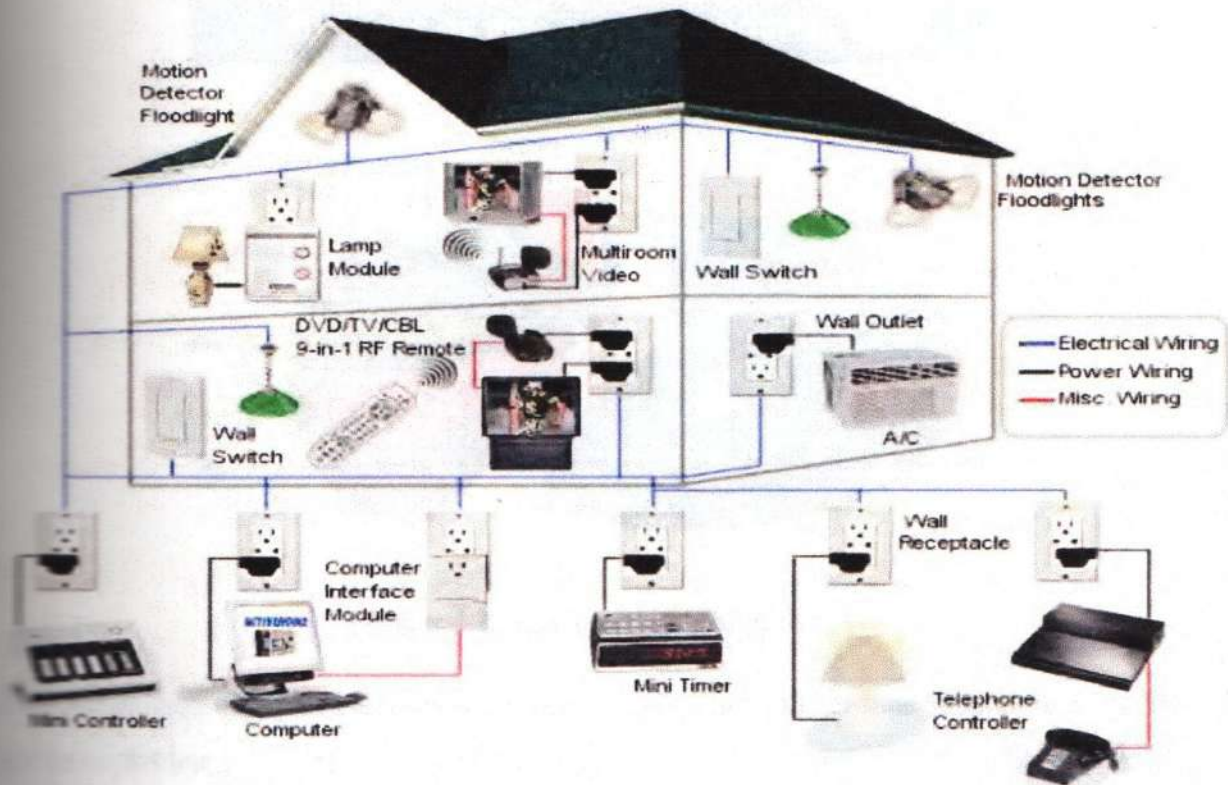

Figure 1.1: An example of home automation system.

1.4 Advantages

In the present day home automation has becoming essential for the purpose of improving life style.

Home automation offers a futuristic way of life in which an individual gets to control the entire house using a smart phone, from turning on a TV to locking or unlocking doors. It also offers an efficient use of energy. Automation system also allows us to control the home appliances and keep an eye on the house from a distance.

It is beneficial to the grandparents who usually stay at home alone. It is also very helpful for the handicap to look after the home and easy to inform if there is any trouble in the house [2].

According to World Health Organization, heart diseases like Asthma or Stroke caused by air pollution kills 37,000 in Bangladesh. Some respiratory diseases caused by excess dust gradually leads to infection. Our country is at the 3rd position in the WHO's Southeast Asian Regional Office (SEARO) region that eleven Asian countries in air pollution. Therefore, a dust level detector is a must in every house of Bangladesh [3].

SOURCES OF PM2.5 AS RECORDED IN 2015

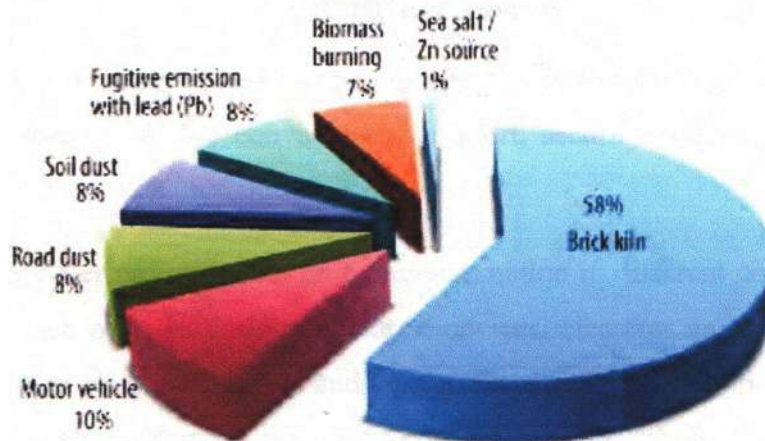

Figure 1.2: Source of dust in air (2015)

BBC News says dust particle level in Dhaka is seven times higher than Singapore. Dust level increases further in winter season. Therefore, it is very important to reduce the dust level in possible places.

CHAPTER 2

Literature review

Home automation or smart homes can be described as introduction of technology within the home environment to provide convenience, comfort, security and energy efficiency to its occupants [4].

There are many other projects done on home automation in different countries. They are all different from each other in designs; features, devices, elements and algorithm. They were designed according to specific needs and availability of components in the respective areas. Some of them are cheap; some of them are very expensive. Availability of both hardware and software is necessary to work. After a long searching, we have found a lot of articles. Searching for security purpose articles, we also found some projects done for garage security. These are mainly done in western countries. Many projects are done only for security purpose with Arduino or Raspberry Pi. Again, the projects are done only for controlling home appliances using Arduino or Raspberry Pi.

There are few projects on Fingerprint recognition module for strong home security issues. One of the projects used biometric method for next generation E-passport. The e-passport, as it is sometimes called, represents a bold initiative in the deployment of two new technologies: Radio-Frequency Identification (RFID) and biometrics [5] [6] [7].

Furthermore, there are projects done on fingerprint recognition module describing the methods how to identify the fingerprints. A wide variety of systems requires reliable personal recognition schemes to either confirm or determine the identity of an individual requesting their services. The purpose of such schemes is to ensure that the rendered services are accessed only by a legitimate user and no one else. Those papers didn't mention about how to use it for home security using any kind of microcontrollers [8] [9] [10].

Face recognition is another excellent and smart way that serves security purpose. We have found projects for door security using face recognition using Raspberry Pi. We avoided this part for the security purpose because error occurs more in face recognition than fingerprint recognition. Fingerprint has high accuracy [11]. They didn't explicitly mention about the security purpose or Raspberry Pi. They have only mentioned about the techniques of recognition. Different people have described the procedure of recognition in different ways. Basically all of them have tried to minimize errors for computer to recognize face [12] [13].

Three researchers of Malaysia proposed a web-based indoor air quality system with GSM and Arduino. The system consists of gas sensor, temperature and humidity sensor, particle dust sensor and wireless sensor network (WSN) node as a wireless transmitter. A desktop computer acts as the base station [14].

According to Chen Shih-Chung, the systems proposed by him is designed that can be easily be adapted for various applications such as control of machines in machining industries, automotive industry, navigating mobile wireless nodes, automating offices etc. [15].

There are few home automation systems that use ZigBee or Bluetooth for the wireless connection. With the help of Wi-Fi [16][17] and due to the introduction of IPv6 the connection of almost unlimited number of embedded devices is possible.

In Bangladesh, we use IPv4.

Isa Elina and Sklavos Nicolas proposed cameras and sensors inputs based system operates on different levels of user's access control, based on passwords policies. The system works through SMS communication via the available GSM network [18] [19].

Al-Ali and Al-Rousan [6] presented a design and implemented Java-based automation system through World Wide Web. It has got a standalone embedded system board integrated into a PC-based server at home [20].

Andrew, the writer of the book "Raspberry Pi Home Automation with Arduino", introduced Raspberry Pi and how to use it for home automation. He described the use of Raspberry Pi with Arduino for Linux operating system. The book describes some home appliances automatic control. First he described how to install all the necessary equipment and all required conditions. Firstly, he gave the history of Arduino and Raspberry Pi with all sockets, required shield specifications and all necessary ports with power supply. We were able to find necessary data of Arduino since we used it. Good examples of thermometer, opening and closing of curtain based on light and temperature data are given. On the other hand, he didn't show any example related to security of home [21].

Annan Zhu, Peijie Lin and Shuying Cheng of Fuzhou University of China described the remote control system of home appliances using android phone through GSM network (2012 International Conference on Control Engineering and Communication Technology). They

focused on the design of Android terminal, the communication between ARM and GSM module. Minimizing the difficulty in supplying the appropriate low-voltage DC for MCU and wireless module by a single live wire was also one of the tasks. Here we have found only the controlling of appliances using android, nothing more than that [22].

An article of Singapore by the authors Thomas Gonnot, Won-Jae Yi, Ehsan Monsef and Jafar Samie showed a protocol standard for home automation system called Home Automation Device Protocol (HADP). Wi-Fi, Bluetooth 4.2, ZigBee IP, 6LoWPAN, IEEE 802.15.4 standards, and Ethernet network layer supporting IPv6 protocol were their components. Mainly they proposed a protocol if-this-then-that. So it connected many devices together using WIFI connection [23].

K. M. Abubeker, Jose J Edathala, Shinto Sebastian from India introduced PIR sensors and an intelligent power saving mode in ATM counter. This uses pyro-electric infrared sensors to detect pedestrians and the ATM users. The system is controlled by the real time clock RTC DS 1307 to differentiate the day and night time with a surveillance video. This gives an excellent security to the ATM counter [24].

According to an article by Suresh, J. Bhavya, S. Sakshi, using PIR sensor with Arduino Mega is a cheap and effective security system that can inform about an intruder through text message. In India, people largely rely on personal security guard for home security. Same goes for Bangladesh. They made this easier and cheaper than costly surveillance video cameras [25] [26].

Again, there is another article to prevent theft in home by P. Satya Ravi Teja, V. Kushal, A. SaiSrikar titled "Photosensitive security system for theft detection and control using GSM technology". They did it using LDR (Light Dependent Resistor) based sensor which acts as an electronic eye for detecting the theft or attempt, and a signaling procedure based on SMS using GSM (Global Systems for Mobile communications) technology. It is also quite cheap [27].

These are the few previous researches done on similar topic. It is mentioned earlier that most of them lack either the security system or the controlling system. We avoided the face recognition system for home security because people are trying to minimize a lot of error in recognition of face. The face has to be at a particular angle so that the computer is able to recognize. Therefore fingerprint recognition module is more reliable for door security. Some

of these projects are done with Arduino, some of them are done with Raspberry Pi. The components, like sensors and shields are also of different models. Our aim is to combine these systems together i.e. controlling home appliances and security system with Arduino keeping it as cheap as possible.

CHAPTER 3

Brief introduction of all the components

3.1 Introduction

To begin with the project, let's get the idea of all the components that we used for the project. It is very important to know all the information about both hardware and software specifications. The components we are using are as follows:

1. Arduino Mega 2560
2. Arduino Uno R3
3. Sensors:
 - a. Gas Sensor MQ-2 (SEN 00091)
 - b. PIR Motion Detector (HC – SR501)
 - c. Dust Sensor
 - d. LM 35 Temperature Sensor
 - e. Light Dependent Resistor (LDR) sensor
4. Bluetooth Module HC-05
5. GSM Shield SIM900A
6. Relay Module (4 Channel)
7. LCD Display with header (16x2)
8. Fingerprint Recognition Module (FPM10A)
9. Breadboard
10. Adapter
11. Servo Motor
12. DS1307 RTC
13. Piezo Buzzer

3.2 Arduino ATmega 2560

The Arduino Mega 2560 is a microcontroller board based on the ATmega2560 [28]. It has 54 digital input/output pins (of which 14 can be used as PWM outputs), 16 analog inputs, 4 UARTs (hardware serial ports), a 16 MHz crystal oscillator, a USB connection, a power jack, an ICSP header etc. It contains everything needed to support the microcontroller; simply connect it to a computer with a USB cable or power it with an AC-to-DC adapter or battery to get started.

In our project we have used an adapter with the Arduino Mega 2560 while will provide the power supply to all the components.

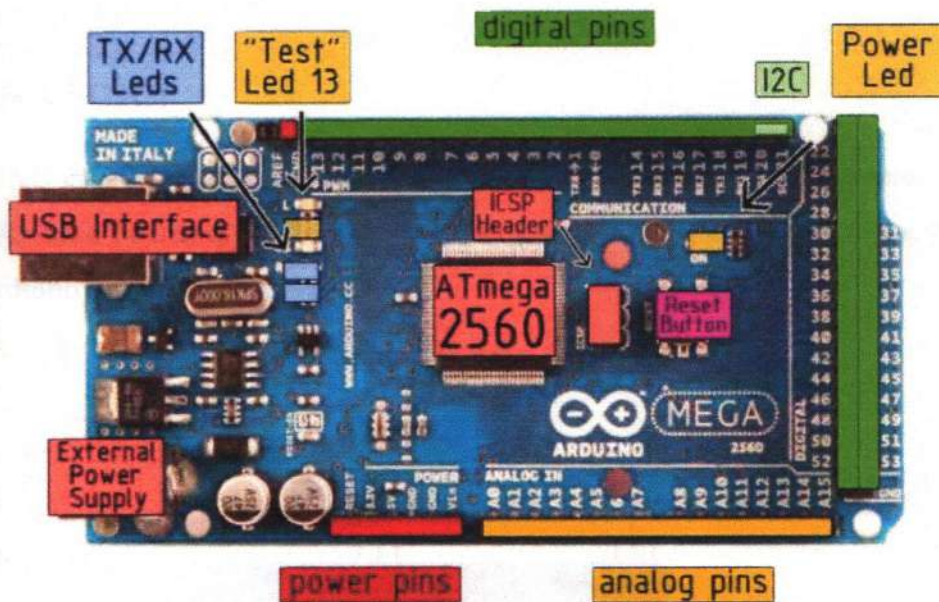

Figure 3.1: Arduino ATmega 2560.

Technical Specifications:

Summary: This board operates in 5V 40-50mA. It has 54 pins in which 16 are analog input pins. Analog input, digital input, PWM pins are separated.

Input and Output:

Each of the 54 digital pins on the Mega can be used as an input or output using `pinMode()`, `digitalWrite()`, and `digitalRead()` functions

USB Overflow of current Protection:

The Arduino Mega has a protecting poly-fuse component that protects USB ports from overflow of current. More than 500 mA automatically breaks the connection until the short or overload is removed.

3.3 Arduino UNO R3:

Arduino UNO is called the 'stock' Arduino. It is easily adaptable to all programming devices. All other Arduino boards are different versions of the UNO board. It has almost all features like Arduino MEGA with less pin-outs.

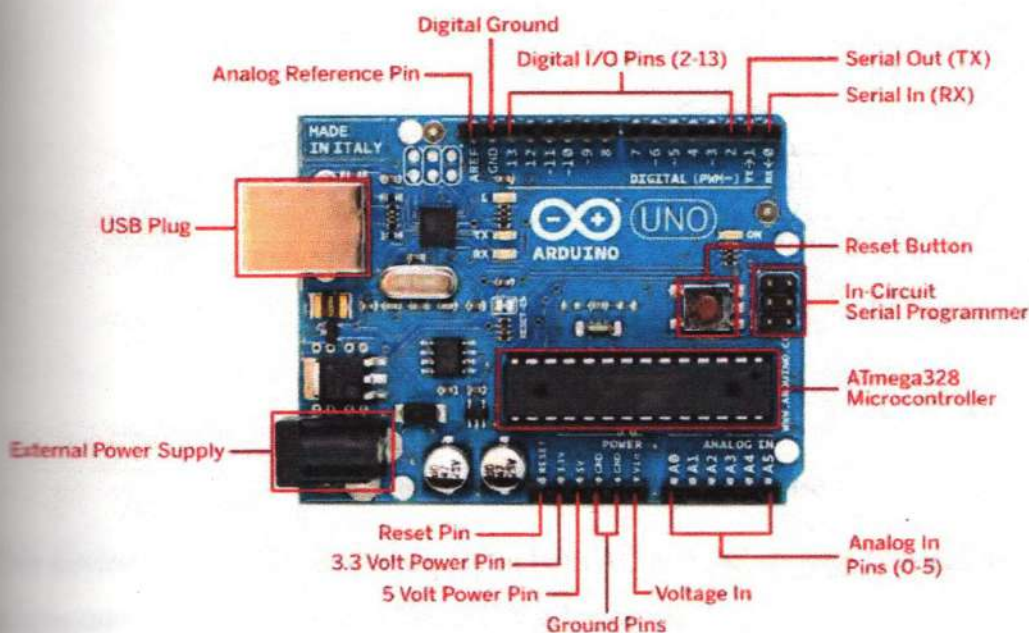

Figure 3.2: Arduino UNO R3 with pinouts.

3.4 Brief Introductions to the Sensors

Introductions and overview of the sensors we used are given below:

3.4.1 Gas Sensor MQ 2:

- a) High sensitivity to carbon monoxide and CH₄, LPG.
- b) Stable and long life

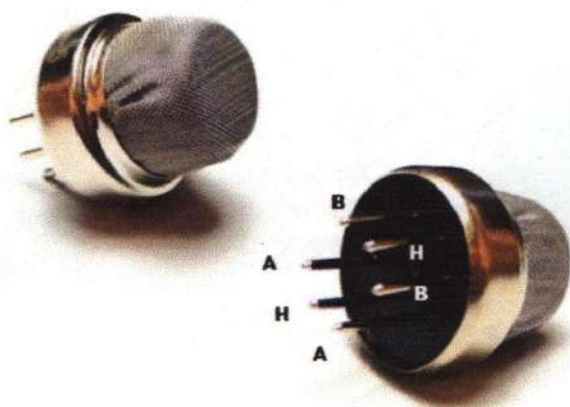

Figure 3.3: MQ 2 Gas Sensor.

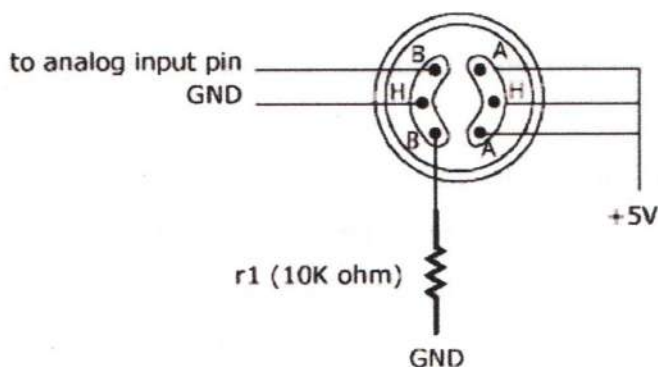

Figure 3.4: Pinout diagram of gas sensor.

This device works in 5V power supply in both AC and DC supply. It works well in room temperature. This also has an adjustable load resistor.

Detecting range: The gas detecting ranges are – (a) 20ppm-2000ppm carbon monoxide, (b) 500ppm-10000ppm CH₄, (c) 500ppm-10000ppm LPG.

3.4.2 PIR Motion Detector (HC – SR501):

HC-SR501 is based on infrared technology, automatic control module, using Germany imported LHI778 probe design, high sensitivity, high reliability, ultra-low-voltage operating mode, widely used in various auto-sensing electrical equipment, especially for battery-powered automatic controlled products.

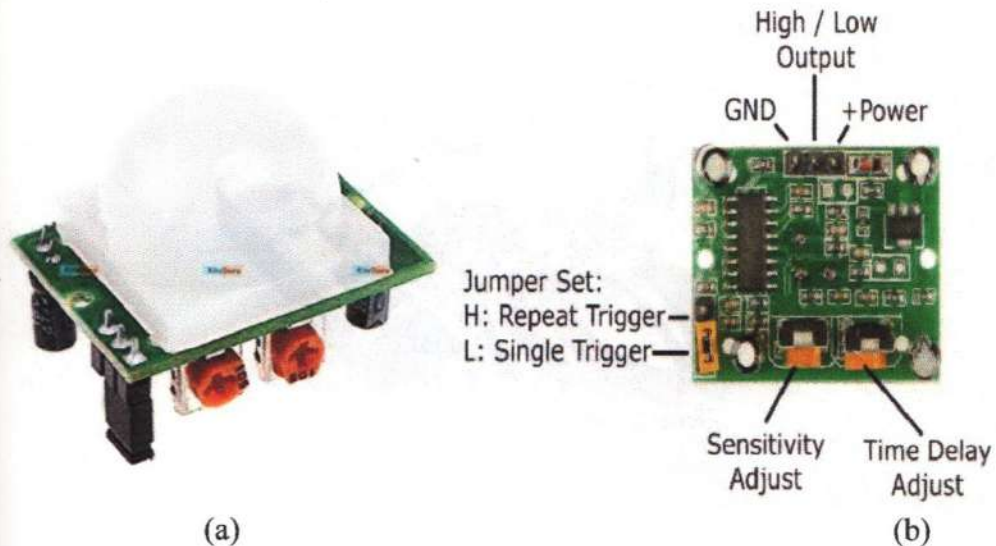

Figure 3.5: (a) PIR Motion Detector (Top view). (b) PIR Motion Detector (bottom view).

Specification: PIR sensor has the capability to operate in 5-20V supply. At 3.3V the sensor will be high and at 0V it is low.

Application: It is widely used in security purpose, body induction toys and industrial automation toys.

Pyro-electric infrared switch is a passive infrared switch which consists of BISS0001, pyro-electric infrared sensors and a few external components. It can automatically open all kinds of equipment including incandescent lamp, fluorescent lamp, intercom, automatic, electric fan, dryer and automatic washing machine, etc.

It is widely used in enterprises, hotels, stores, and corridor and other sensitive area for automatically lamplight, lighting and alarm system.

3.4.3 Optical Dust Detector:

GP2Y1010AU0F, a very low current consuming device, used for detecting dust level is able to detect very fine dust particles like cigarette smoke in air. An infrared emitter and a

phototransistor are placed to detect reflected light from air. To distinguish smoke particles from house dust, it uses pulse pattern of output voltage. It uses photometry to detect dust particles.

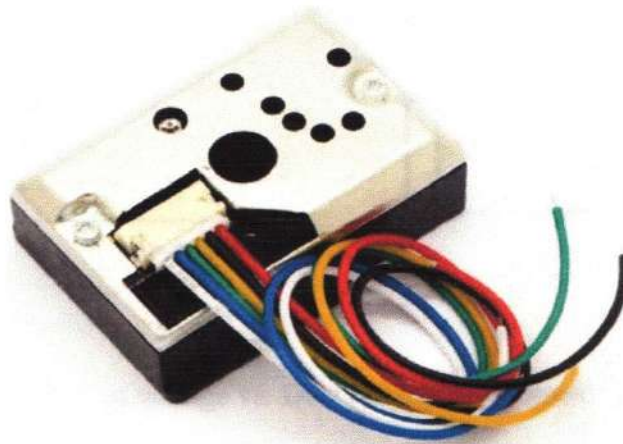

Figure 3.6: Optical dust detector.

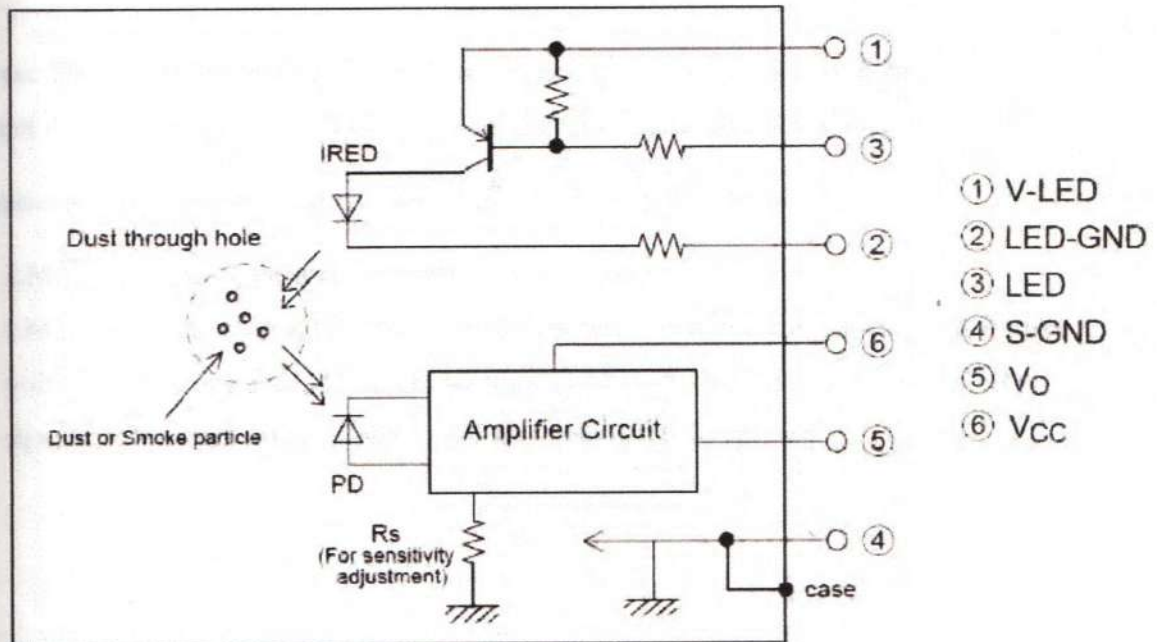
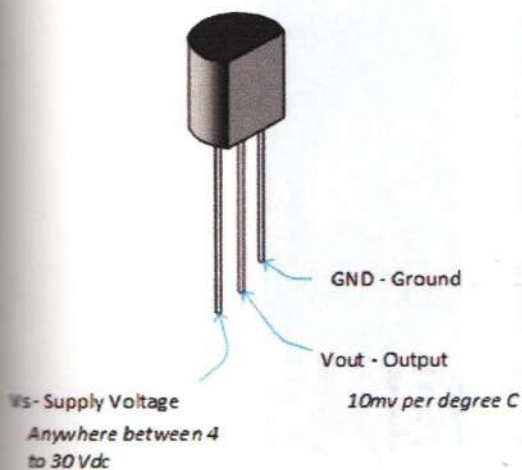
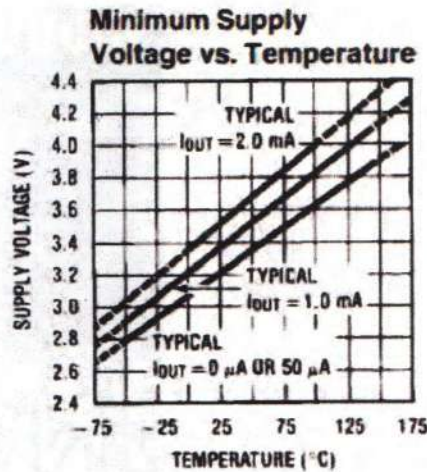

Figure 3.7: Internal schematic of optical dust detector.



(a)



(b)

Figure 3.9: (a) Pin configuration of LM35 temperature sensor. (b) The graph shows linear relationship of applied voltage and temperature.

FEATURES: This sensor is easy to use because it is already calibrated into Celsius. It is very low costing. It can take -55° to $+150^{\circ}\text{C}$ range. It takes only 0.1W for 1mA load.

Introduction of the Modules

Introductions of communicating modules are given below:

Bluetooth Module HC-05:

Bluetooth module breakout is a well-known, most available and latest wireless serial cable. This module is an easy SPP (Serial Port Protocol) module. This module consists of Bluetooth V2.0+EDR (Enhanced Data Rate) 3 Mbps Modulation with 2.4GHz radio transceiver and baseband. It uses CMOS technology with CSR Blue core 04 External chip Bluetooth systems and AFH (Adaptive Frequency Hopping Features). This module provides switching mode between master and slave mode which means it is not able to receiving or transmitting data.

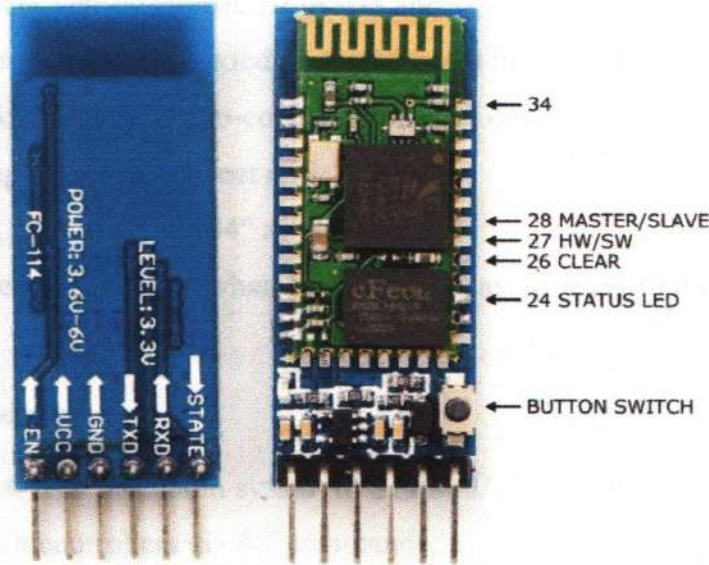

Figure 3.10: Bluetooth Module HC-05 with pin configurations.

Hardware features: Bluetooth takes 1.8V for operation, 3.3 to 5 V I/O. Sensitivity is typically -80dBm and UART interfacing with baud rate programmable. Edge connector is also present.

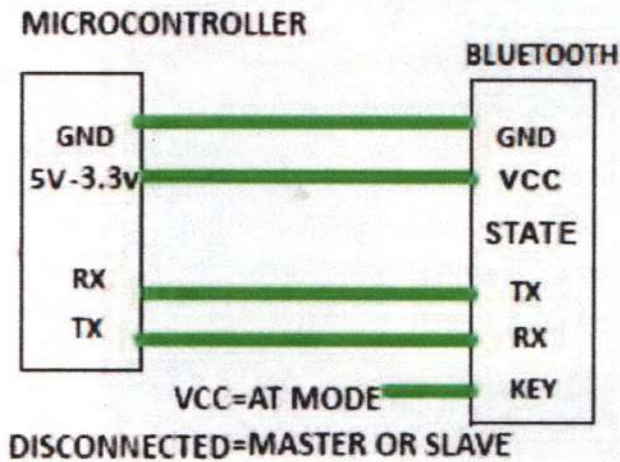

Figure 3.10.1: Typical circuit connection of Bluetooth module.

Software Features:

- a. Slave default Baud rate: 9600
 - Data bits: 8.
 - Stop bit: 1.
 - No parity.

- b. PIO9 and PIO8 can be connected to red and blue led separately. When master and slave are paired, red and blue led blinks 1time/2s in interval, while disconnected only blue led blinks 2times/s. Auto-connect to the last device on power as default.
- c. Permit pairing device to connect as default.
- d. Auto-pairing PINCODE:”1234” as default.
- e. Auto-reconnect in 30 min when disconnected as a result of beyond the range of connection.

GSM SIM900A Module:

It is a breakout board with minimum system of SIM900A Dual-band GSM/GPRS module. It can communicate with controllers via AT commands.

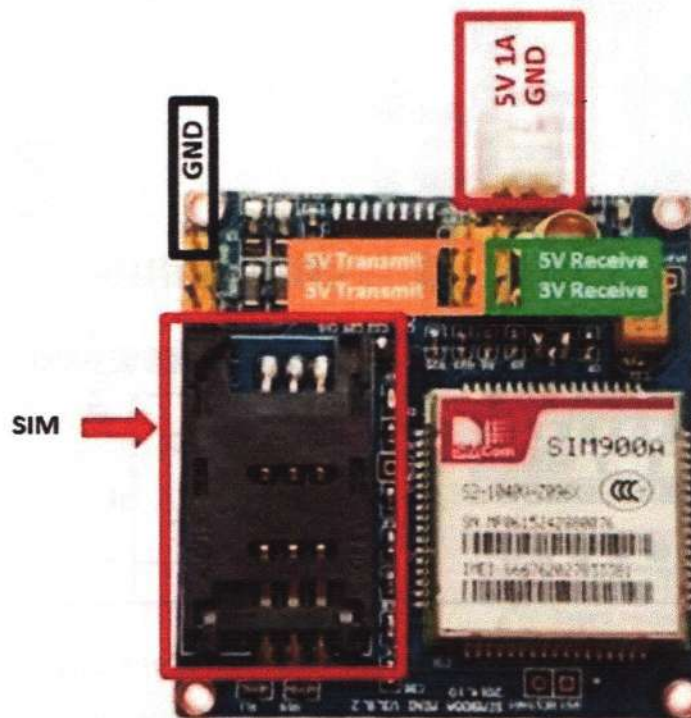

Figure 3.10.2: GSM SIM900A.

Features:

- a) Quad-Band 850/ 900/ 1800/ 1900 MHz
- b) Dual-Band 900/ 1900 MHz
- c) GPRS multi-slot class 10/8GPRS mobile station class B
- d) Compliant to GSM phase 2/2+Class 4 (2 W @850/ 900 MHz)

- e) Class 1 (1 W @ 1800/1900MHz)
- f) Control via AT commands (GSM 07.07 ,07.05 and SIMCOM enhanced AT Commands)
- g) Low power consumption: 1.5mA(sleep mode)
- h) Operation temperature: -40°C to +85 °C

Electrical Characteristics: Maximum power supply can be given 5.5V. Its consumption is 300mA for pulse and 500mA for continuous current. Highest baud rate is 115200 bps.

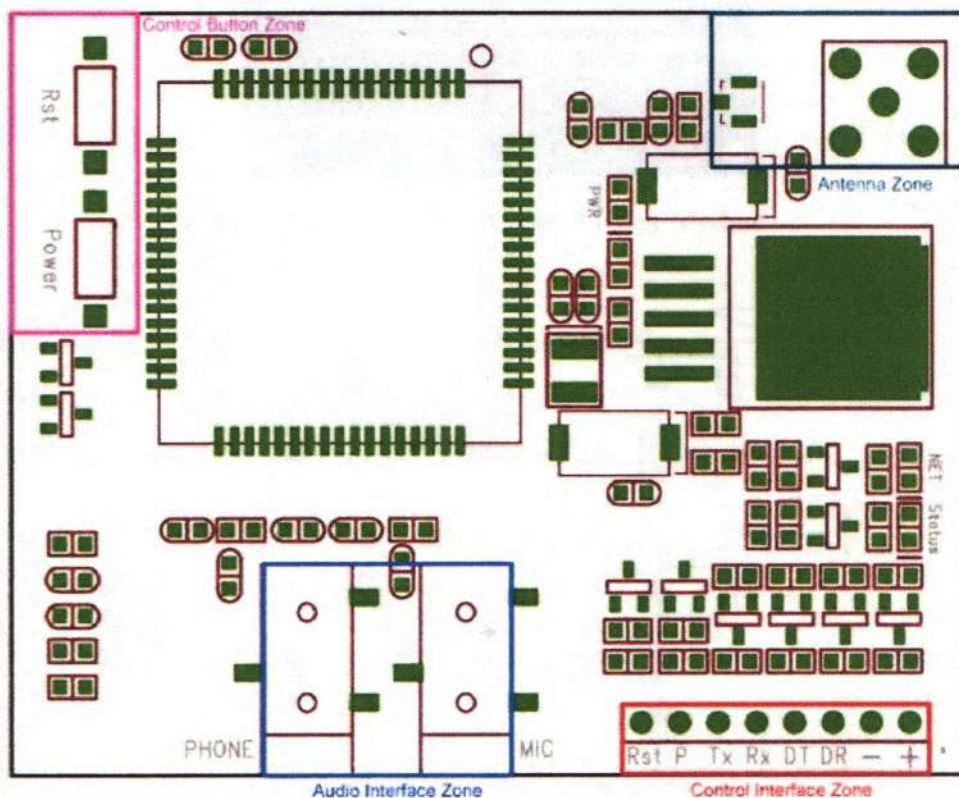

Figure 3.10.3: Hardware of GSM SIM900A (top view).

The GSM plays a very important role wireless communication. It has to follow different protocols to perform secure wireless communication. They are:

- a. **Specifications for data:** Maximum 85.6 Kbps with GPRS class 10. USSD and PPP stack specified. Coding scheme CS 1,2,3,4
- b. **Specifications for SMS:** Point-to-point MO and MT, SMS cell broadcast, text and PDU mode.
- c. **Software Features:** 0710 MUX protocol with embedded TCP/UDP protocol and FTP/HTTP

Relay Module 5V 4-channel:

It is a 5V 4-channel relay board used to control various appliances. It can be used with or without microcontrollers. Each 5V relay needs 20mA driving current. It has LEDs for indication of output status.

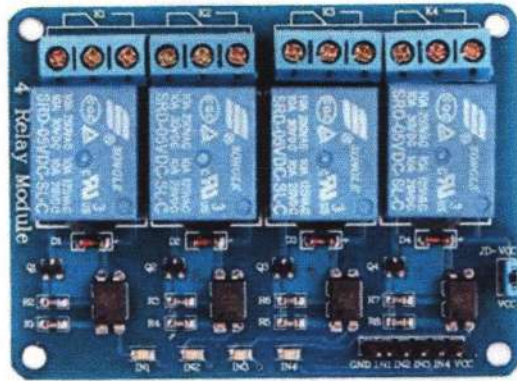

Figure 3.10.4: A 5V 4-Channel Relay Module.

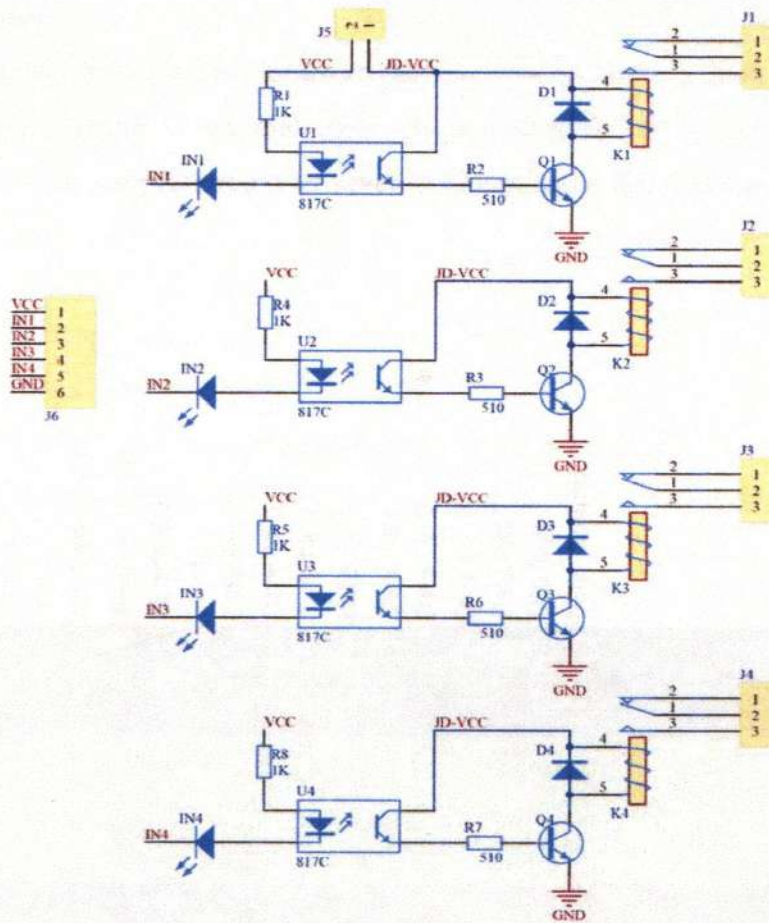

Figure 3.10.5: Schematic of 4-Channel Relay module.

Interface pin functions: All interfacing pin configuration is given at table 4.2

Fingerprint Recognition Module (FPM10A):

Optical fingerprint module is used to detect and verify individual with biometrics. This module performs image rendering, calculation, feature-finding and searching. It is compatible with any microcontroller.

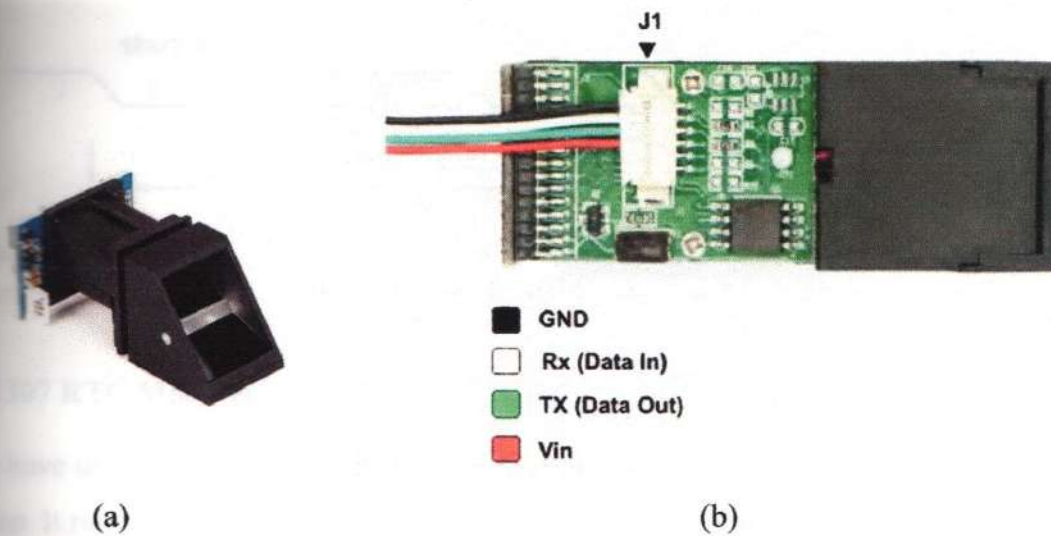

Figure 3.10.8: (a) Fingerprint recognition module. (b) Module pinouts.

Introduction of the module: Typically works in 100mA with peak 150mA. Baud rate is 9600 bps. It has the capability to store 256 sample prints. The template size has to be 512 bytes. This sensor takes less than 0.5s to capture fingerprint. Further it has the highest accuracy of all biometric processes.

Principle of Operation:

The operation has 2 steps: enrollment and matching (1:1 or 1:N). The system will generate and store a template of finger images by processing the image. User has to enter finger two times. User enters the finger through the optical sensor while matching. The system compares the live finger with specific template designed in the module during 1:1 matching. The system will search the whole fingerprint library for 1: N matching. At last the system returns the result matched or failed in both processes.

Hardware connection: The module communicates with MSU with 3.3V or 5V power via serial interface. TD (pin 3 of P1) connects with RXD (receiving pin of MCU), RD (pin 4 of P1) connects with TXD.

Serial Communication Protocol: It is semi-duplex asynchronous serial communication. Baud rate ranges from 9600-115200 bps. We used 9600 bps. Transferring frame format is 10 bit; 8 data bits with the LSB first and an ending bit. There is no check bit.

Reset Time: It takes 500ms for initializing. Module can't accept any command at this time.

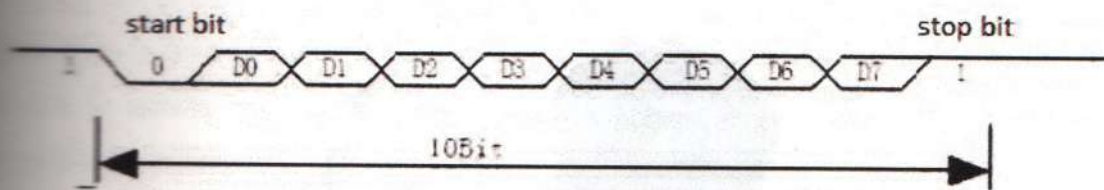

Figure 3.10.9: Transferring frame format.

DS1307 RTC Module:

We have used this module in the system to measure time and date. It is easy to use and very cheap. It runs on battery. It is easy to program the time in both 12 hours and 24 hours system.

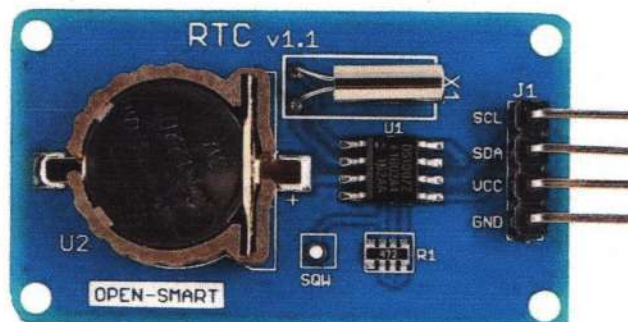

Figure 3.10.10: DS1307 RTC Module.

Piezo Buzzer:

The module is a low cost alarm buzzer called Piezo Buzzer. This device is the alarm for this system. It starts ringing when temperature increases very high and smoke is detected. It also starts ringing when PIR sensor is high.



Figure 3.10.11: Piezo Buzzer.

CHAPTER-4

METHODOLOGY

4.1 Introduction:

According to the proposed system, we have designed the system structure shown in the block diagram. We have designed the model in such a way that it can be kept at a safe place inside the house. All programming and components installation are done and tested inside the laboratory and in home. There are a lot of components and wires that we have used for the system. This is done in the easiest and lowest cost possible. However, the system is flexible and can be customized by the user. Changing one of the components setup has to be compatible with the right software available. Every components used in this system was programmed and tested separately for safety measures and matching with the right driver. Each component was programmed separately with both Arduino Mega and Arduino UNO using different Arduino IDE. Also they were run in different computers. Later on all were combined in a single Arduino IDE. It is not possible to run the system without the Wi-Fi and computer.

This project is divided into two parts: hardware implementation and software implementation.

4.2 Hardware Architecture and Implementation:

Components can be divided into two categories: sensors and modules. All of them are described below:

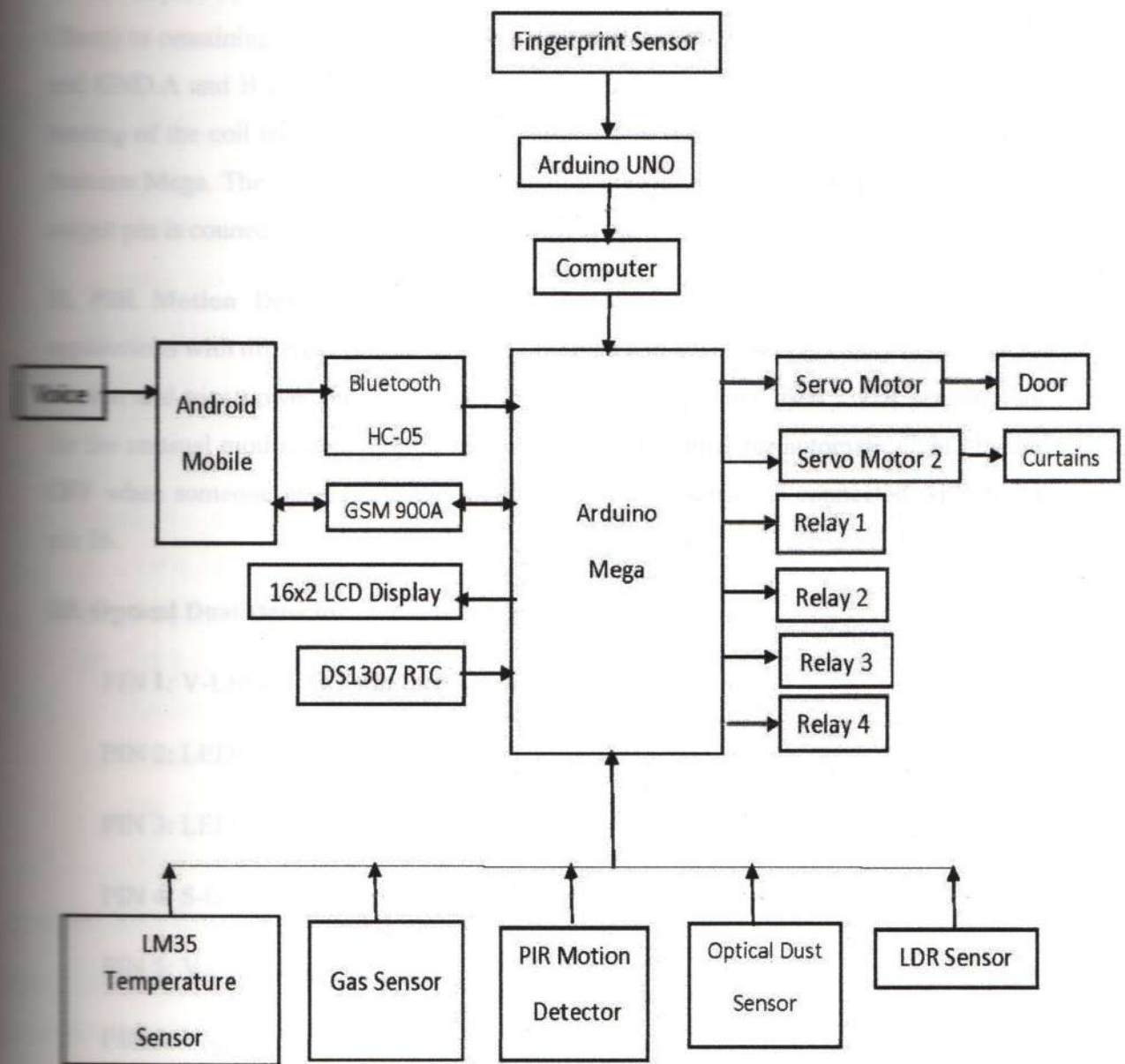

Figure 4.1: Block diagram of the home automation system.

4.2.1 Sensors:

All sensors are connected with the microcontroller through wires. All input voltages are applied from the microcontroller with the computer.

They are described below with diagram. In this section hardware implementation of all sensors are described below:

I. Gas Sensor: In the MQ series of gas sensors, there is a small heater inside with an electro-chemical sensor. Connect both A pins together and B pins together then apply V_{CC} to the coupled A or B pin. We applied GND through variable resistor R_L (2K to 47K Ohms) to remaining coupled A or B pins. The heater pins H and H connected with V_{CC} and GND. A and B pins shouldn't be interconnected. The sensor mainly depends on the heating of the coil the heater uses 5VDC supply. The sensor is directly connected to the Arduino Mega. The output is an analog signal; it is read with an analog input. Gas sensor output pin is connected with arduino mega digital pin 22.

II. PIR Motion Detector: The hardware implementation includes two versions of applications with different power switching outputs and power supply: relay power output version and triac power output version. In this system we have used 2 PIR sensors; one for the unusual motion detection inside the room and another for automatic light ON and OFF when someone enters into the room. PIR security sensor is connected with digital pin 26.

III. Optical Dust Detector: We set up the pin as following:

PIN 1: V-LED- 3.3V (150 Ohms in between)

PIN 2: LED-GND- GND Pin

PIN 3: LED- Digital Pin

PIN 4: S-GND- GND Pin

PIN 5: V_O – Analog Pin

PIN 6: V_{CC} – 3.3V Pin (Direct)

IV. LM35 Precision Temperature Sensor: There are only three pins. The output pin (pin 2) is connected to the analog input of Arduino board.

4.2.2 Modules:

A. GSM SIM900A MODULE: This module has 6 pins in which two pins are V_{CC} and GND. The rest are 3VR, 3VT (3 volts RX and TX) and 5VR, 5VT (5 volts RX and TX). The connections are as follows:

V_{CC} to 5V

GND to GND

5V to digital pin

SVT to digital pin

Before working with the GSM, we have to check the following conditions:

- a. Insert SIM: Placing the SIM card in the card holder marked in the figure. Make sure there is balance in the SIM card.
- b. Connect the antenna: We fix the RF antenna to the SMA antenna connector and tighten it by rotating the nut.
- c. Connect the pins: We connect the pins according to our schematic diagram.
- d. Power the modem: We power the modem for suitable power supply (>1A). We have used an adapter for the power supply.
- e. Check the status of LED:
 - i. PWR LED: Red LED lights immediately
 - ii. STS LED: Green LED lights after 1-2 seconds
 - iii. NET LED: Blue LED will start to blink fast at first for few second (searching for network) and blink slowly once the modem registers with the network.
 - iv. Baud rate: We chose the baud rate 9600. The connections are made according to the figure above with the LCD monitor. All pin configurations are done according to the pin configuration.

B. Bluetooth Module HC-05:

Bluetooth module plays a very important role in interfacing the home appliances with the Android phone but it has only four pins for connection. Pin connections are given below:

Arduino Pins	Bluetooth Pins
RX (PIN 0)	TX
TX (PIN 1)	RX
5V	V _{CC}
GND	GND

Table 4.1: Bluetooth pin interface.

C. 4-channel Relay Module:

All the components are with the relay. The relay is on after all the sensors and modules are high. In case of door unlocking, when the fingerprint matches the relay is on and the door opens by servo motor. In case of all sensors, when they are high the relay turns on to send text message to the phone. Relay, obviously as a switch is connected with all the home appliances. Also controlling of relay is possible through the GSM. We have also controlled the room curtains with the help of relay and servo motor. The connection is done according to the schematic diagram.

D. DS1307 Real Time Clock Module:

There are 4 pins in the RTC module and marked as in the figure. They are connected according to the labels directly with the Arduino Mega.

E. 16x2 LCD Display: A register select (RS) pin that controls where in the LCD's memory data will be writing is connected with analog pin 9. An Enable pin that enables writing to the registers is connected with analog pin 8. Data pins (D4 -D7) are connected with corresponding analog pins (4, 5, 6, 7). Power supply pins +5V and GND is connected in the breadboard.

F. Pin configuration table: All connections of the sensors and modules are given below:

LCD Display pins:

SL	Ardiuno MEGA	LCD
1	4	D7
2	5	D6
3	6	D5
4	7	D4
5	8	En
6	9	Rs

Table 4.2: Pin connection of LCD display with microcontroller.

Sensor pins:

SL	Ardiuno Mega	Sensors
1	22	Gas
2	26	PIR(security)
3	28	LDR
4	30	PIR(light)

Table 4.3: Interfacing sensors with microcontroller.

Module pins:

SL	Modules	Ardiuno MEGA
1	Sim900	2
2	Bluetooth	3
3	RTC	Digital pin
4	Servo(window)	3
5	Servo(door)	7
6	Piezo buzzer	44, 45
7	Relay(fan)	36
8	Relay(light-2)	38
9	Relay(light-1)	40

Table 4.4: Interfacing modules with microcontroller.

There are 2 DC-DC buck converter of 6V 3A and 8V 3A respectively are used. An adapter of 12V 5A is also added in the circuit. The SIM900A needs 3A current to run. Otherwise no text message will be sent or received. To maintain a stable condition these extra modules are used. High or low voltage and current configuration can damage the whole system. If there is any chance of deducting power supply from the system, the whole system will collapse. To avoid such problem battery and adapter are used. Therefore there will be no problem in the security system.

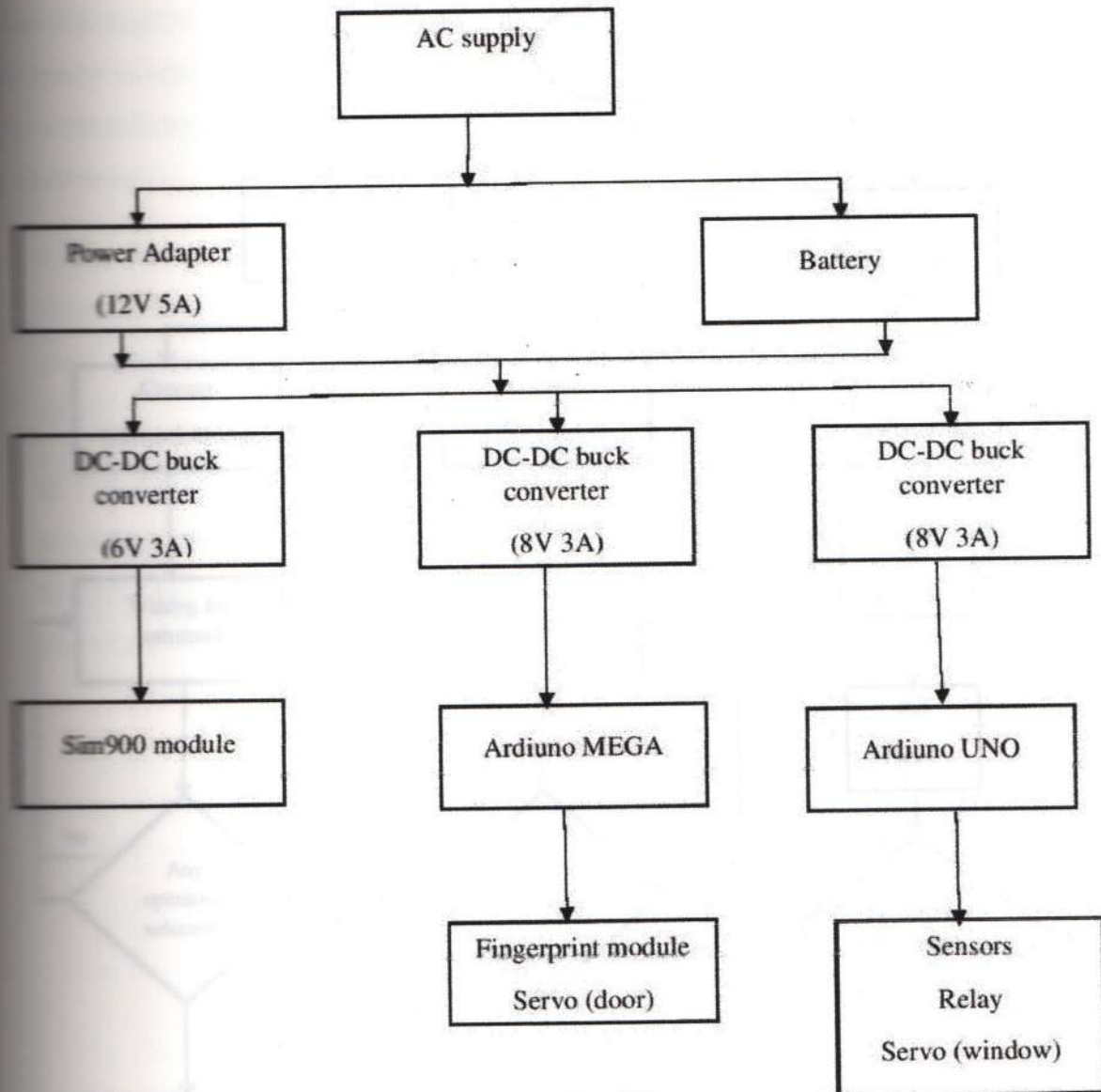

Figure 4.2: Power supply block diagram of the home automation system.

4.3 Software implementation:

The software we used is Arduino IDE 1.8.5. All code is written in a single IDE called sketch. All the components are Arduino compatible so we have included respective Arduino Adafruit Library. For this section we have also divided the working procedure into four parts: sensors, modules, Android Application and Voice controller.

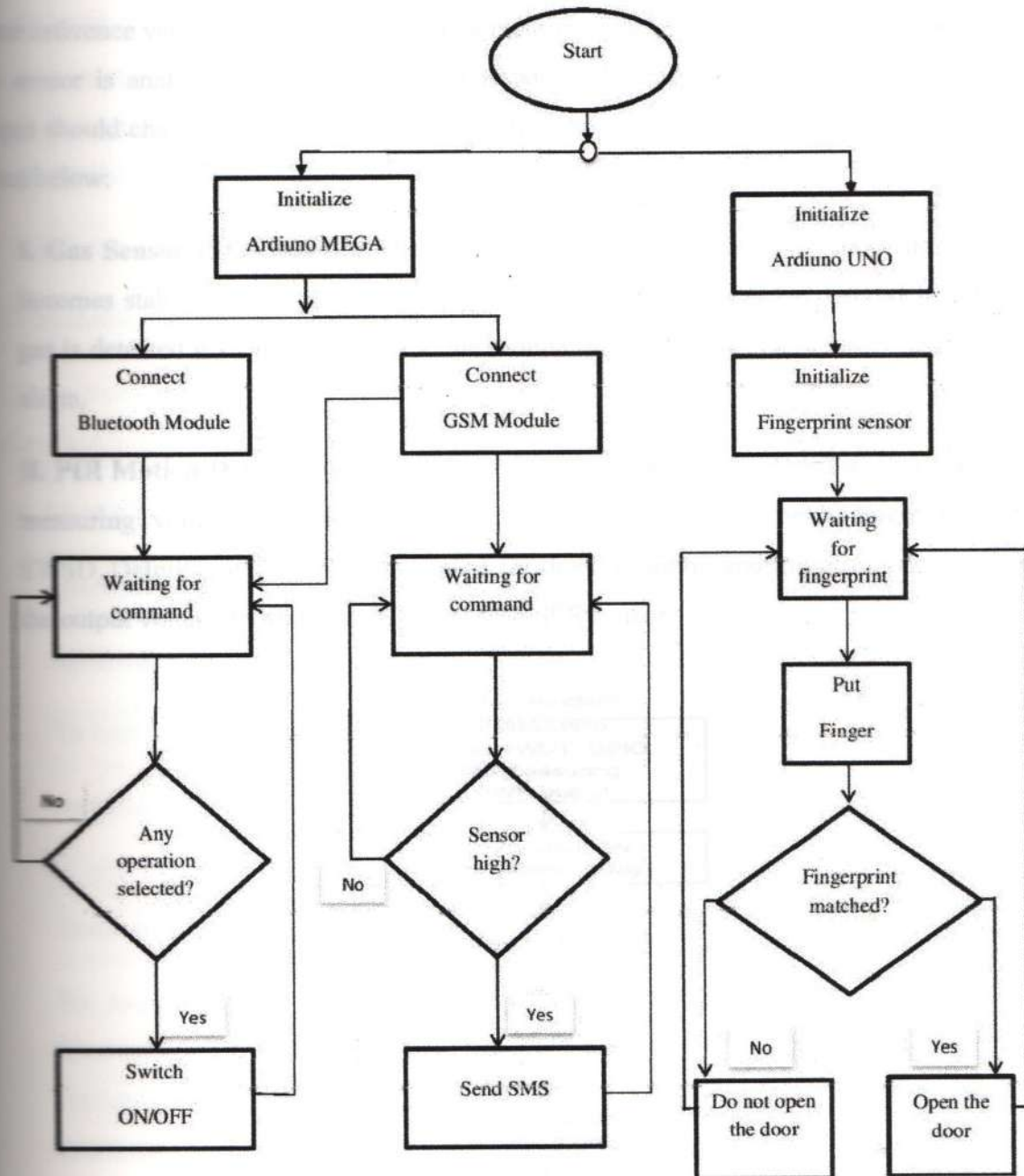

Figure 4.3: Flowchart of the home automation system.

4.3.1 Sensors:

A sensor is an electronic device that responds to any change in physical phenomenon or environmental variables like heat, pressure, humidity, movement etc. The sensors are all analog-to-digital sensors. These sensors produce continuous output signal. Computer cannot read or analyze continuous values so all the sensors need to be calibrated with respect to

some reference value or standard for accurate measurement. After that the signal produced by the sensor is analyzable. One of the most important characteristics of sensors is that the output should change linearly with the input. The working process of the sensors we used is given below:

I. Gas Sensor (SEN 00091): The sensor takes three minutes time before the reading becomes stable. This is programmed with the function `analogWrite()` and delay. When gas is detected it sends a message to the mobile through GSM module and rings the fire alarm.

II. PIR Motion Detector (HC – SR501): The main part of the algorithm is to focus on measuring voltage from PIR sensor. It also includes input measurement filtration `SWSD_DeInit()` and `SNSD_Init()` used for deinitialization and initialization, then find the output voltage by filtration of signal from PIR sensor.

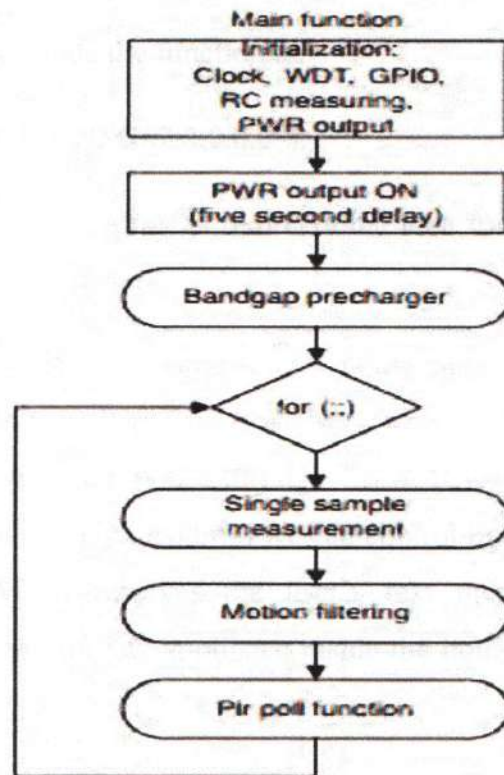

Figure 4.4: Motion detection software flowchart.

III. Optical Dust Sensor: It is an analog sensor. To read dust value `analogRead()` is used. For calculating and converting into voltage: $dustDensity = 0.17 * calcVoltage - 0.1$. It gives both the output voltage and the dust density. The output is shown in the monitor. The system sends a text message to the phone when the dust intensity rises.

IV. LM 35 Precision Temperature Sensor: This sensor reads the temperature of the room and displays it to the LCD monitor. The system sends text message through GSM to the Android phone. The temperature is shown in Celsius. It starts with the function `analogRead()` and the formula for Celsius is

$$\text{ADC value} = \text{sample} * 1024 / \text{reference value.}$$

4.3.2 Modules:

We have mentioned the names of the other modules of the system earlier. Their software implementations are described below:

A. GSM Shield SIM900A:

Basic AT commands: To change sending mode the function is:

```
mySerial.println("AT+CMGF=1");
```

To read SMS in text mode the function is:

```
mySerial.println("AT+CNMI=2,2,0,0,0");
```

In this system the GSM works as bidirectional data transmitter. It has two types of functions: sender and receiver.

We have used the GSM to control any home appliances from a distance. The Bluetooth works only in Personal Area Network (PAN). We can control all home appliances from outside the house through GSM. It works like a Bluetooth but in a larger network area. Through Android we can control lights, fans, air conditioner, TV, door etc via GSM. It receives the user's text message and passes it to the microcontroller to control any appliance inside the house. Here the GSM works as a receiver.

For the security system, the GSM sends text message based on all the sensors used in this system. If the PIR sensor gets any unusual movement inside the house, the user gets a text message. This means that there is someone inside the house in absence of the user. The GSM also plays an important role in fire alarming system with the help of LM35 temperature sensor and the gas sensor. When the temperature rises very high and CO (carbon monoxide) is detected, the system sends text message through GSM.

The gas component ranges are mentioned above in the component introduction section. Also, when the dust level of the room increases, the user gets text message. These wireless communications are done both inside and outside the house. Therefore, the user is able to get information from all the sensors. It doesn't need any of the Android Application or the Voice Control Application. Here the GSM acts as a sender.

B. Bluetooth Module HC-05:

The default baud rate for AT mode is 38400. First we have to manually enter the AT mode. It keeps reading data after entering. The Bluetooth module relays the command and displays it when the command is given in the serial monitor. Determining communication speed we used the function `setup()` in place of `begin()` and `findBaud()`. To send a command to the module the function `cmd()` is used. The key (cmdPin) pin is activated to put the module in command mode where 'AT' commands are recognized. The default functions of mode start and end are used for the speed 38400. In our system, we control the home appliances through Android Application via Bluetooth. The Android App interfaces with microcontroller via Bluetooth. Switching of home appliances is its main function. In this system we only give command from the Android to the system. Both the Voice Control Application and Android Application are used to control home appliances. No command is returned through the Bluetooth.

C. 4 Channel Relay:

There is no programming for the relay. It is a part of hardware connection only.

D. Fingerprint Recognition Module (FPM10A):

One of the most important parts of this system is fingerprint recognition module. While designing the home automation system we prioritized the matter of home security and tried to figure out a way to come up with a solution. As we know every human being has unique finger print of his own that deviates from all other and we put that uniqueness to the task. Finger print sensor is already used widely for biometric identification and in our case we used that very same technology to provide security to our home automation project. From other biometrics we have chosen this because it has the highest accuracy level. The sensor that we used is quite easy to get

and we mounted the sensor with an Arduino Uno as it is quite flexible to work with. As mentioned earlier, we followed the algorithm that has two steps: enrollment and print matching. The scanner we are using is designed for Arduino and data can be transferred to Android phone. In this scanner the algorithm looks for ridges and lines end of a finger where a ridge splits in two. These distinctive features are called minutiae. Rather than matching the whole fingerprint, matching those minutiae reduces processing time. The first and foremost thing that has to be done is enrollment of finger prints that you want to create a database with. In order to allow the people to enter the home their finger prints must be taken and saved to system memory through enrollment process. For that particular purpose we used an Arduino codes under the same name that is available in the library of the sensor. The sensor itself has internal memory to save up to 256 types of different finger prints that is without having external memory which can even increase the numbers. The user data is kept in the computer hard drive as database.

We have given 3 persons fingerprints for the door to open. The door opens only when the fingerprints of those 3 persons match. 4-5 seconds delay is needed to close the door again. There is a servo motor to open and close the door. The following figure portrays the step:

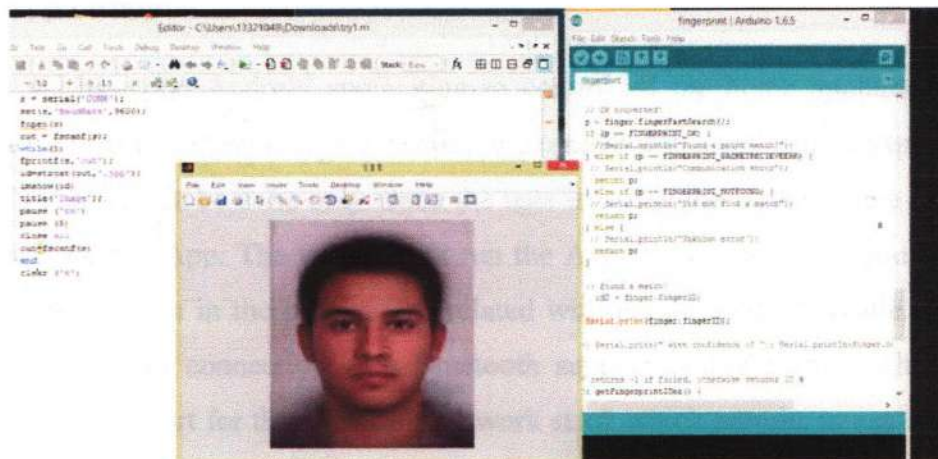

Figure 4.5: Screenshot of Matlab code in computer.

E. DS1307 Real Time Clock Module:

The code is written in Arduino IDE 1.8.5. We need to import DS1307 RTC library and Wire in the sketch. There is no analog reading in this module. Time, date, day, month and year is calculated this module. The functions used for this module:

To start: `RTC.start()`

To stop: `RTC.stop()`

Read clock: `RTC.readClock()`

Reading the time: `RTC.getHours()`

`RTC.getDate()` and so on.

Writing time: `RTC.setHours()`

`RTC.setMinutes()` and so on.

Finally, the date, day and time are displayed in the LCD display and kept record with all the sensors.

4.3.3 Android Application:

In this system we have the Android application to control all the home appliances. From Android phone we select any home appliance from the options that appear in the App then we select ON or OFF. This can be done only when the user is inside the house. There should be Wi-Fi connection for the App. The user cannot run the App from outside the house even if there is internet connection in the phone. It is related with the Bluetooth module. It allows establishing point-to-point connection with Bluetooth support devices. This technology is known by Android's support for the Bluetooth network stack which permits to exchange data wirelessly.

The Android Software Development Kit (SDK) provides all necessary tools to develop Android Application (API). This application is a Java based program. The Android uses .apk file to install the application. The code is written in Android Studio IDE. All appliances buttons list will appear first. Then the user has to choose an option. Later the action button ON and OFF appears. There are 2 layouts of the code structure, two Class code and user

permission code. These are written in Android Studio IDE. The code is written according to the appearance of the options in the phone.

To open device lists:

```
import android.widget.Button;
```

```
import android.widget.ListView;
```

To create variables for Bluetooth:

```
private BluetoothAdapter myBluetooth = null;
```

```
private Set<PairDevice>
```

After initialization, methods of Java is written ending with user permission code. Then the code is written in Arduino IDE. The code starts with initializing characters as 'String'.

4.3.4 Voice Controlling Android Application:

In this project we have also used Android Voice Application to control the home appliances. All home appliances can be turned ON or OFF by sending voice command. We are not calling it a Voice Recognition system because this App allows everyone to speak. This is kept easy and flexible for the user that can be used with any microcontroller. The system receives voice command from anyone. The Google Assistant Voice Application receives the sound wave as a "String" through paired Bluetooth Serial Modules and converts it into text. Then the command is processed for the relay to work.

If we say "Hello" to the Android phone it returns a string *Hello# to the Bluetooth module. "*" and "#" indicates start and stop bits.

CHAPTER 5

RESULTS AND ANALYSIS

5.1 Results

After connecting and programming all the components with the, we conducted the experiment. We have run all the components according to the proposed system. We have designed a prototype of a house placing inside room and outside door. All modules and microcontroller are kept together with a lot of wires. This part is the main centre of the home automation system. The sensors are placed inside the room (Figure 5.1). All commands are given from Android App and voice command.

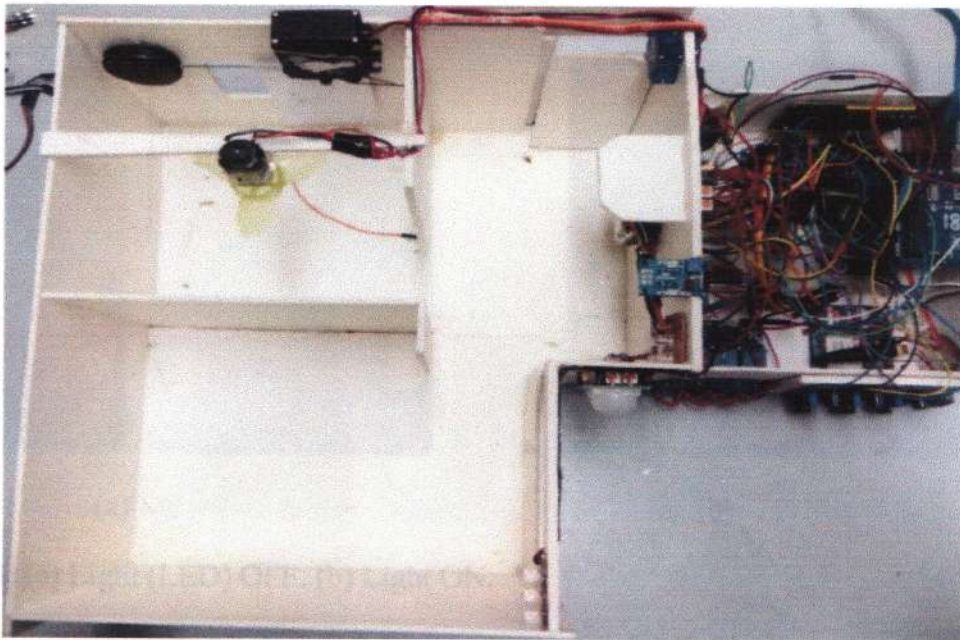

Figure 5.1: Top view of the home automation system showing different sensors and modules placed in the required places.

Fan is turned ON and OFF using voice command (Figure 5.2).



(a)



(b)

Figure 5.2: (a) Fan OFF. (b) Fan ON.

Light is turned ON and OFF using voice command (Figure 5.3). With the help of PIR sensor the presence of a person is detected so light turns on.



(a)



(b)

Figure 5.3: (a) Light (LED) OFF. (b) Light ON.

It shows “cleaning needed” when dust level increases (Figure 5.4).

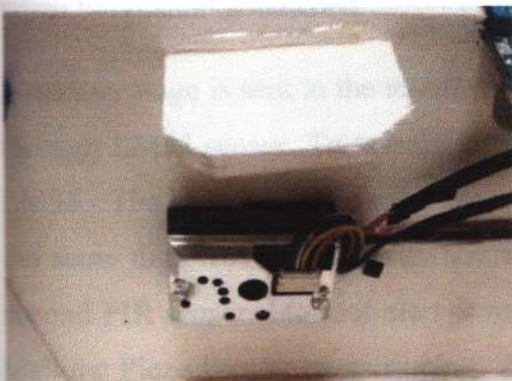

(a)



(b)

Figure 5.4: (a) Dust sensor. (b) Response of high dust level in room.

Curtains close and open due to the intensity of light measured with the help of LDR (Figure 5.5).



Figure 5.5: (a) Curtain open. (b) Curtain closed.

The security system works as follows:

The user puts finger on the scanner; the door opens when fingerprint matches. There is 3-4 seconds time delay in scanning the fingerprint.

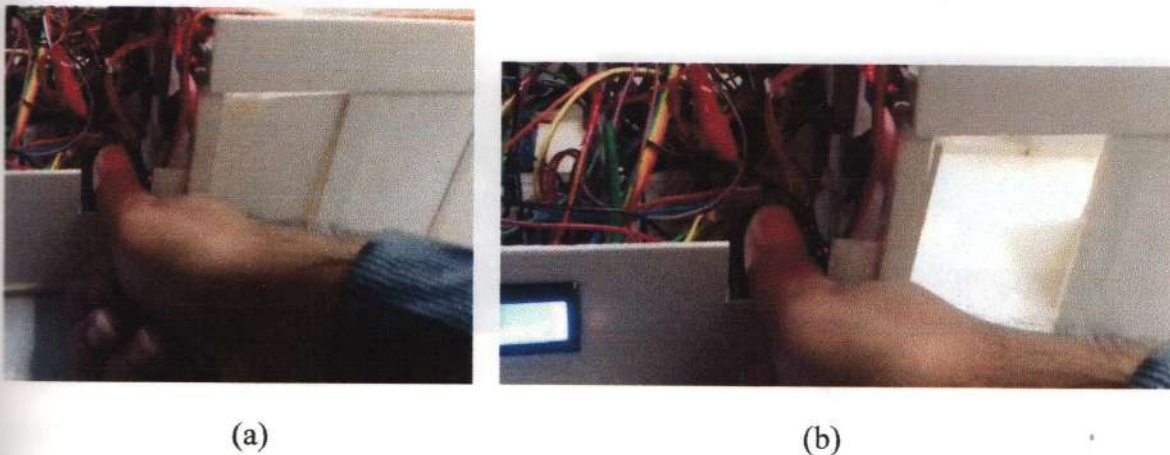

Figure 5.6: (a) The user pressed finger on the scanner, the door is closed. (b) The door opened when the scanning matched.

A text message is sent in the mobile when temperature is very high; temperature is measured through LM35 sensor. To test fire alert system, we have used a lighter and hold it near the LM35. The LCD display shows “gas leakage” when smoke and harmful gas is detected. At the same time it is notified with text message. LCD display shows theft detection from the second PIR sensor. Intruder alert is notified via text message too. When all the sensors are high the Piezo Buzzer starts ringing. When there is fire inside the house notification of both high temperature and smoke is sent through SMS.



(a)



(b)

Figure 5.7: (a) Testing fire near the temperature sensor. (b) Notification of fire.

The system sends text and also displays it to the monitor when there is gas leakage inside the house.



(a)



(b)

Figure 5.8: (a) Notification in mobile. (b) Warning in the LCD display.



(a)

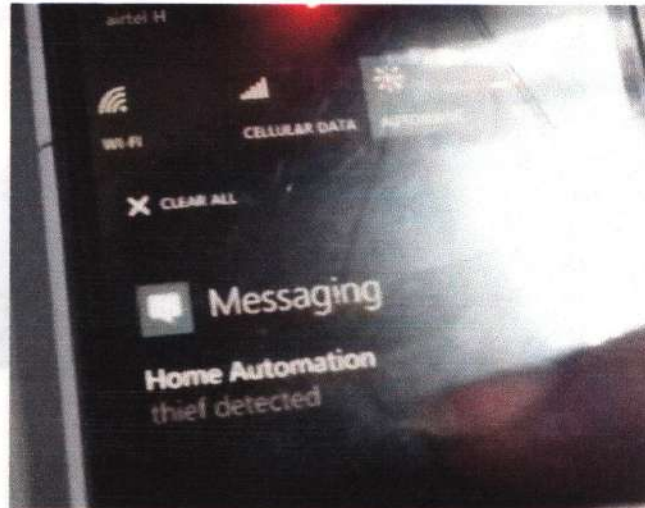

(b)



(c)

Figure 5.9: (a) Testing the PIR sensor for detecting intruder. (b) Thief detection mobile notification. (c) LCD display showing thief detected.

Another feature of this project is automatic lights on and off. When PIR sensor detects presence of a person inside the house, the light turns on automatically. The light turns off when the person leaves (Figure 5.10).



(a)

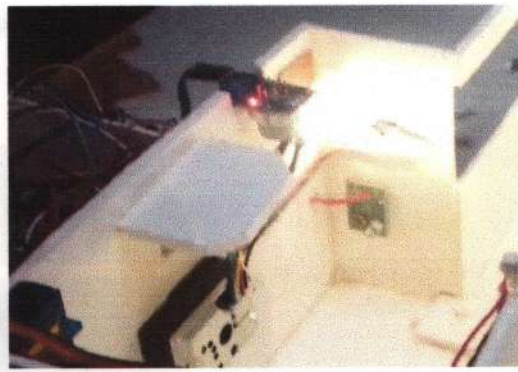

(b)

Figure 5.10: (a) Light is off when no one is inside the room. (b) Light is on when someone enters the room.

The last feature of this project is controlling appliances with GSM and Voice App. We have used specific characters for switching on and off the light and fan separately. The mobile receives the command as string with start and stop bits indicating. It takes around 2 seconds to process the command and work.

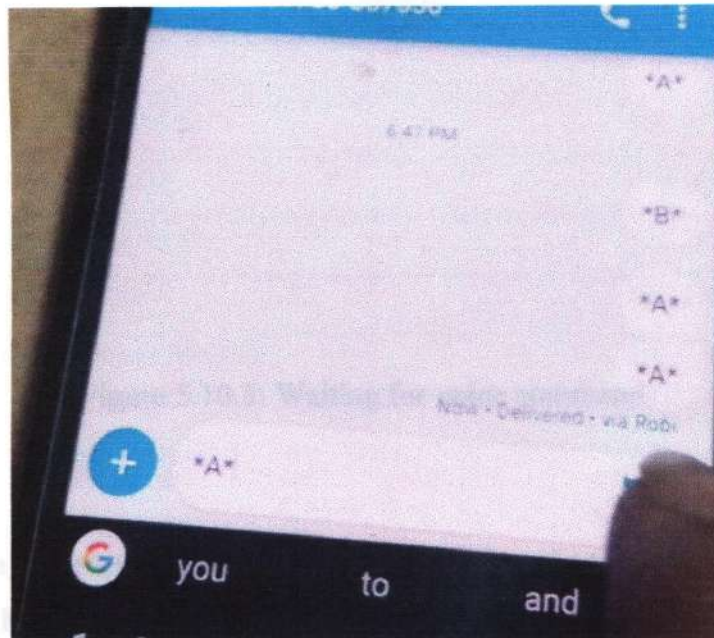

Figure 5.10.1: Sending text command to control fan. .



Figure 5.10.2: Initializing Voice Recognition App.

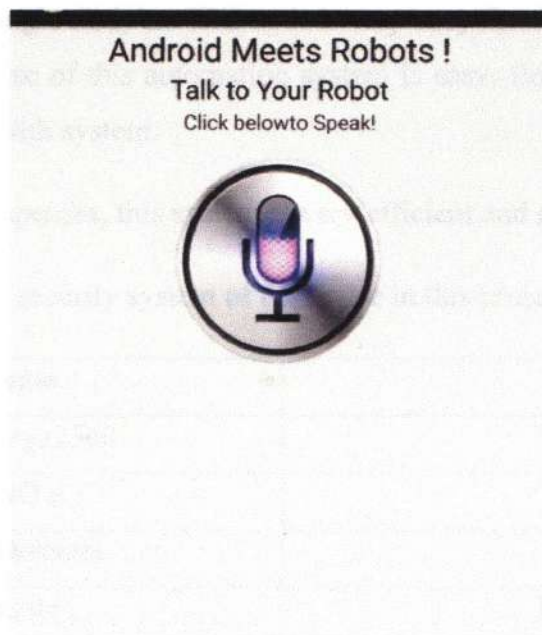

Figure 5.10.3: Waiting for voice command.

5.2 Analysis

This thesis is not a complete project. This is a prototype of another larger system for larger house. There are a lot of important matters to observe in this project. After performing all the tasks we have seen that the voltage and current is not the same always as given in the components' specifications. We have used a lot of devices that that need high and constant

supply. Otherwise there is delay in the task. There is also a risk of destroying the devices if there is very high voltage supply.

The number of wires that we have used in this project doesn't make significant power loss but the modules need constant power supply. In case of the GSM module, it needs 3A current to send and receive text message. Otherwise no communication is possible. From the test we conducted it seems the mobile communication is very fast.

To maintain a constant power supply, we had to add DC-DC buck converter and an adapter. There will be a problem if there is no electricity or internet.

All sensors need time to give a stable reading like, temperature and fingerprint sensor. Again, in processing voice command, it has maximum 4 seconds delay.

The sensitivity of the sensors can be varied according to the need of the user. The whole program is written in a single Arduino IDE so it is very easy for the user to change any kind of function. Overall the use of this automation system is easy, flexible and reliable. We can easily add extra features with system.

If we analyze about the expenses, this system is very efficient and reliable.

Our expenses only for the security system of the house in this project:

Components	Price
Arduino ATmega2560	TK 1,150
Arduino UNO R3	TK 490
PIR Motion Detector	TK 125
GSM Module	TK 3,000
Fingerprint Recognition Module	TK 4,487
Relay	TK 320
Total	9,572

Table 5.1: Expense of the security system.

A regular security guard has salary TK 4000-5000 for 12-16hrs [31]. So yearly expenditure

$$\text{TK } 5000 \times 12 = \text{TK } 60000$$

$$\text{Savings in a year} = 60,000 - 9,572 \text{ (in Taka)} = \text{TK } 50,428$$

That is a lot of money to save in a year. If we add the expenses of the home appliances with this amount, it is not very expensive. The automatic control of the home appliances will also bring down the electricity bill because the appliance will automatically turn off.

6. ...
E. ... ready. The
w. ... and some
d. ... controlling
an. ... at device
bu. ...

A. ...
pr. ... will
te. ...

Al. ...
we. ...
Tec. ...
un. ...

6.2 ...
The ...
ba. ...
wh. ...
sys. ...
circu. ...

The p. ...
be. ...
sys. ...
sour. ...

Ther. ...
to ex. ...
exp. ...
exp. ...

CHAPTER 6

CONCLUSION

6.1 Discussion

From the project carried out, we find the system effectively low cost and user friendly. The whole house remains under the user's control all the time. In future we may find some devices that are more reliable, faster and cheaper. We have tried to make a good controlling and security system. The components that we have used can be changed with the latest device but it should have the right software and the right driver.

All the tasks of this project are done successfully. We were able to fulfill our goals as proposed in this system. We had our limitations in time and expenses but we hope that it will serve as basis of other latest AI systems as that of western countries.

Almost all scientific and latest technologies have both good and bad sides. That doesn't mean we should avoid technology. This type of work inspires us to do better for our country. Smart Technology is a blessing for our country. We should try to avoid the bad consequences and use it for our betterment.

6.2 Limitations

There are some limitations observed throughout our project. Since our project is internet based, our home appliances are totally controlled through internet access. As we control the whole system through internet, we need to confirm high speed of internet. Otherwise, the system delay will occur as Ethernet shield will not be working as a network provider to the circuit.

The project relies on power supply. So if the power supply fails, the internet connection will be halted. Then database access will be stopped. For this, without security system the whole system will not be worked. In our project, security system is powered by another power source for security safety.

Though it needs less circuitry but its cost is not in minimal range. To get facility, users need to expense for this. The cost of installing a home automation system can be to a certain extent expensive. But it depends on the apparatus. The more sophisticated the system is the more expensive it will be.

This real time server base system is limited to only one person which means only one person can operate the system at a time.

If there is any break due to rupturing of cables or the fibers then the total system will be crashed. So, this will not be the case of radio signals or the other signals. There will be a difficulty of receiving signal.

If the individual does not handle the equipment safely or make use of the exact key to carry out the operations, human error can occur. Human faults also direct to the destructions of the device. Then there will be system collides.

Home automation has numerous drawbacks. For having home automated system, people will be lazier. That ultimately might end up with making great harm in human social and professional life.

In exceptionally uncommon cases, the unwavering quality of the home computerized gadgets fluctuates (decreases). It depends generally on the innovation utilized and the progressions being finished.

6.3 Future Scope

As we have mentioned earlier this thesis is not a complete project. This is just a basic structure of another complete system. We have done all the basic necessities of a typical house. The tasks that we have done are not the only tasks the components are able to do. There are a lot of other scopes for this project.

More appliances can be added in this system with a powerful relay module. Garage automatic door system can be added for extra security. All available smart devices can interface with this system including a car.

DS1307 Real Time Clock module is a very important device. This project could have a cloud database to save all the data. Readings from all the sensors with date and time can be saved.

Room air purifier can be added to this system to make it more efficient. We can add a surveillance camera outside the house for extra security.

Solar power system can make this system extra cheap and durable. Then the system can run with the solar power.

This project can be developed by replacing text communication with voice communication..

The notification system cab changed to voice communication system.

S
A
P
L
B
ter
[4]
[5]
A
S,
[6]
and
P
[7]
A
C
[8]
K
S
[9]
20
[10]
ver
Inte
[11]
[12]
mul
Comp

REFERENCES

- [1] Li, Rita Yi Man; Li, HerruChing Yu; Mak, Cho Kei; Tang, Tony Beiqi. "Sustainable Smart Home and Home Automation: Big Data Analytics Approach" (PDF). *International Journal of Smart Home*. **10** (8): 177–198.
- [2] <http://www.thedailystar.net/backpage/air-pollution-kills-37000-people-every-year-1290760>
- [3] <http://www.bbc.com/news/av/world-asia-18275363/high-pollution-hits-bangladesh-capital>
- [4] Wikipedia. Home automation, http://en.wikipedia.org/wiki/Home_automation
- [5] Tieyan Li, "Employing Lightweight Primitives on Low-Cost RFID Tags for Authentication", *Vehicular Technology Conference 2008. VTC 2008-Fall. IEEE 68th*, pp. 1-5, 2008, ISSN 1090-3038.
- [6] Raphael C.-W. Phan, Jean-Philippe Aumasson, "Next generation networks: Human-aided and privacy-driven", *Innovations in NGN: Future Network and Services 2008. K-INGN 2008. First ITU-T Kaleidoscope Academic Conference*, pp. 331-336, 2008.
- [7] TziporaHalevi, Haoyu Li, Di Ma, NiteshSaxena, Jonathan Voris, Tuo Xiang, "Context-Aware Defenses to RFID Unauthorized Reading and Relay Attacks", *Emerging Topics in Computing IEEE Transactions on*, vol. 1, pp. 307-318, 2013, ISSN 2168-6750.
- [8] Shatha J. Alghamdi, Lamiaa A. Elrefaei, "Dynamic User Verification Using Touch Keystroke Based on Medians Vector Proximity", *Computational Intelligence Communication Systems and Networks (CICSyN) 2015 7th International Conference on*, pp. 121-126, 2015.
- [9] J. Fazenda, D. Santos, P. Correia, "Using Gait to Recognize People", *Computer as a Tool 2005. EUROCON 2005. The International Conference on*, vol. 1, pp. 155-158, 2005.
- [10] Robert Larkins, Michael Mayo, "Adaptive Feature Thresholding for off-line signature verification", *Image and Vision Computing New Zealand 2008. IVCNZ 2008. 23rd International Conference*, pp. 1-6, 2008.
- [11] <https://www.bayometric.com/fingerprint-vs-facial-recognition/>
- [12] Lingfeng Zhang, Pengfei Dou, Shishir K. Shah, Ioannis A. Kakadiaris, "Hierarchical multi-label framework for robust face recognition", *Biometrics (ICB) 2015 International Conference on*, pp. 127-134, 2015.

- [13] Yu Zhang, Dit-Yan Yeung, "Semisupervised Generalized Discriminant Analysis", *Neural Networks IEEE Transactions on*, vol. 22, pp. 1207-1217, 2011, ISSN 1045-9227.
- [14] S. M. Saad, A. R. Mohd Saad, A. M. Y. Kamarudin, A. Zakaria and A. Y. M. Shakaff, "Indoor air quality monitoring system using wireless sensor network (WSN) with web interface," *2013 International Conference on Electrical, Electronics and System Engineering (ICEESE)*, Kuala Lumpur, 2013, pp. 60-64.
- [15] Shih-Chung Chen, Chung-Min Wu, Yeou-Jiunn Chen, Jung-Ting Chin, Yu-Yin Chen, "Smart home control for the people with severe disabilities", *Applied System Innovation (ICASI) 2017 International Conference on*, pp. 503-506, 2017.
- [16] X. Zhao, "The strategy of smart home control system design based on wireless network," in *Computer Engineering and Technology (ICCET), 2010 2nd International Conference on*, vol. 4, 2010, pp. V4-37.
- [17] R., Pecorella, T., Viti, R., & Carlini, C. Fantacci, "Short paper: Overcoming IoT fragmentation through standard gateway architecture.," *2014 IEEE World Forum on Internet of Things (WF-IoT)*, pp. 181-182, 2014.
- [18]
https://www.researchgate.net/publication/275769946_Smart_Home_Automation_GSM_Security_System_Design_Implementation
- [19] Isa, Eleni & Sklavos, Nicolas. (2017). Smart Home Automation: GSM Security System Design & Implementation.
- [20] Al-Ali, Member, IEEE & M. AL-Rousan, "Java-Based Home Automation System R." *IEEE Transactions on Consumer Electronics*, Vol. 50, No. 2, MAY 2004.
- [21] Dennis, A. K. (2013). "Raspberry-Pi Home Automation with Arduino". United Kingdom, UK: Packt Publishing Ltd.
- [22] Z. Annan, S. Lin, C. Shuying, "Design and Realization of Home Appliances Control System Based on The Android Smartphone", *International Conference on Control Engineering and Communication Technology*, China, 2012.
- [23] Piyare, R., Tazil, M.: Bluetooth based home automation system using cell phone. In *Consumer Electronics (ISCE), 2011 IEEE 15th International Symposium on*, pp. 192-195. (2011).

- [24] K. M. Abubeker, J. J. Edathala and S. Sebastian, "Some investigations on 'PIR' SENSOR and their application on significant energy savings in ATM counter," *2013 IEEE Conference on Information & Communication Technologies*, JeJu Island, 2013, pp. 37-41.
- [25] Suresh S., J. Bhavya, S. Sakshi, K. Varun and G. Debarshi, "Home Monitoring and Security system," *2016 International Conference on ICT in Business Industry & Government (ICTBIG)*, Indore, 2016, pp. 1-5.
- [26] <http://ieeexplore.ieee.org/stamp/stamp.jsp?tp=&arnumber=7892665&isnumber=7892628>
- [27] P. S. R. Teja, V. Kushal, A. S. Srikar and K. Srinivasan, "Photosensitive security system for theft detection and control using GSM technology," *2015 International Conference on Signal Processing and Communication Engineering Systems*, Guntur, 2015, pp. 122-125.
- [28] <https://www.arduino.cc/en/Main/arduinoBoardMega>
- [29] <http://dSPACE.Bracu.ac.bd/bitstream/handle/10361/4209/THESIS%20REPORT.pdf?sequence=1>
- [30] <http://kth.diva-portal.org/smash/get/diva2:679674/FULLTEXT01.pdf>
- [31] <http://www.thedailystar.net/news-detail-39670>